

AVANT-GARDE DESIGN

DECORATIVE PROFILES

*for your interior*

MARDOM  
DECOR





# Spis treści

INDEX

- 5 O NAS**  
ABOUT US | ÜBER UNS | À PROPOS DE NOUS
- 6 MATERIAŁY**  
MATERIALS | MATERIALIEN | MATÉRIAUX
- 7 WYKOŃCZENIA**  
FINISHES | AUSFÜHRUNG | FINITIONS
- 8 LEGENDA**  
LEGEND | LEGENDE | LÉGENDE
- 9 LISTWY ELASTYCZNE**  
FLEXIBLE MOULDINGS  
FLEXIBLE LEISTEN  
MOULURES SOUPLES
- TECHNOLOGIA LIGHTGUARD®**  
LIGHTGUARD® TECHNOLOGY  
LIGHTGUARD® TECHNOLOGIE  
TECHNOLOGIE LIGHTGUARD®
- 10 DLACZEGO WARTO WYBRAĆ LISTWY MARDOM DECOR?**  
WHY CHOOSE MARDOM DECOR MOULDINGS?  
WARUM MARDOM DECOR PROFILE WÄHLEN?  
POURQUOI CHOISIR LES PLINTHES MARDOM DECOR?
- 12 MARDOM DECOR ATELIER**
- 14 LISTWY KARNISZOWE**  
CURTAIN PROFILES | GARDINENBLENDEN | LES CORNICHES
- 18 LISTWY PRZYPODŁOGOWE**  
SKIRTING | SOCKELLEISTEN | PLINTHES BLANCHES
- 24 LISTWY ŚCIENNE**  
WALL MOULDINGS | WANDPROFILE | LES MOULURES MURALES
- 32 LISTWY SUFITOWE**  
CORNICE MOULDINGS | DECKENLEISTEN | LES MOULURES DE PLAFOND
- 44 LISTWY OŚWIETLENIOWE**  
LIGHTING MOULDINGS  
LICHTLEISTEN  
CORNICHES D'ÉCLAIRAGE
- 50 LAMELLI - LAMELE ŚCIENNE**  
LAMELLI - WALL PANELS  
LAMELLI - WANDPANELEE  
LAMELLI - LES LAMELLES
- 78 PANELE ŚCIENNE**  
WALL PANELS  
WANDPANELEE  
PANNEAUX MURAUX
- 86 DEKORACJE**  
DECORATIVE ELEMENTS  
ZIERELEMENTE  
ÉLÉMENTS DÉCORATIFS
- 114 AKCESORIA**  
ACCESSORIES  
ZUBEHÖR  
D'ACCESSOIRES
- 127 INFORMACJE TECHNICZNE**  
TECHNICAL INFO  
TECHNISCHE INFORMATIONEN  
INFORMATIONS TECHNIQUES
- 132 INDEX**  
TABLE OF PRODUCTS  
PRODUKTLISTE  
LISTE DE PRODUITS

Mardom Quality · Mardom Quality · Mardom Quality



3

2

1

1. MD360

2. MD346

3. MD325

# O nas

MARDOM  
DECOR

ABOUT US | ÜBER UNS | À PROPOS DE NOUS

pl

**Mardom Decor to jedna z wiodących marek produkujących listwy dekoracyjne i sztukaterię. Produkty wykonane są z najwyższej jakości wodoodpornych materiałów, co gwarantuje perfekcyjny wygląd listew przez wiele lat. W asortymencie znajdują się setki wzorów, kreowanych we współpracy ze znanymi projektantami przemysłowymi. Tworzymy produkty dedykowane do wszystkich stylów wnętrzarskich - od minimalizmu i prostych form, do bogatych, klasycznych zdobień. Produkty Mardom Decor cieszą się uznaniem klientów - właśnie dlatego, zostały nagrodzone w wielu prestiżowych konkursach branżowych.**

en

Mardom Decor is one of the leading brands producing decorative mouldings and stuccowork. The products are made of the highest quality waterproof materials, which guarantees the perfect appearance of the mouldings for many years. The assortment includes hundreds of designs, created in cooperation with renown industrial designers. We create products dedicated to all interior styles - from minimalism and simple forms to rich, classic decorations. Mardom Decor products are appreciated by customers, which is why they have been awarded in many prestigious industry competitions.

de

Mardom Decor ist einer der führenden Markenhersteller von dekorativen und besonders schönen Stuckelementen. Unsere Produkte werden aus den hochwertigsten Materialien hergestellt, und sind gegen Wasser resistent. Dies garantiert die perfekte Optik über viele Jahre. Das Sortiment umfasst Hunderte von Designs, die in Zusammenarbeit mit namenhaften und renommierten Designern entstanden sind. Wir entwickeln Produkte für alle Einrichtungsstile vom Minimalismus und einfachen Formen bis hin zu reichen und klassischen Dekorationen. Die Produkte von Mardom Decor werden von den Kunden geschätzt, weshalb sie bei vielen renommierten Branchenwettbewerben ausgezeichnet werden.

fr

Mardom Decor est un des principaux fabricants de moulures décoratives et stuc. Les produits sont fabriqués à partir de matériaux imperméables de la plus haute qualité, et garantissent un aspect parfait des moulures pendant de nombreuses années. L'offre comprend des centaines de modèles créés en collaboration avec des designers industriels renommés. Nous créons des produits dédiés à tous les styles d'intérieur - du minimalisme avec des formes simples, à des aspects classiques riches en décors. Les Produits Mardom Decor sont appréciés des clients - et ont été récompensés lors de nombreux concours prestigieux de l'industrie.



# Materiały

MATERIALS | MATERIALIEN | MATÉRIAUX

pl

Produkty Mardom Decor wykonywane są z 2 rodzajów materiału: PolyForce® oraz ProFoam®. Każdy z nich ma swoje cechy i zastosowanie, ale łączy je jedno. Oba są wodoodporne i będą służyć Ci przez wiele lat.

en

Mardom Decor products are made of 2 types of material: PolyForce® and ProFoam®. Each of them has its own characteristics and uses, but they have one thing in common. Both are waterproof and will serve you for many years.

de

Mardom Decor Produkte bestehen aus 2 verschiedenen Materialarten: PolyForce® und ProFoam®. Jeder von ihnen hat seine eigenen Eigenschaften bei Nutzung und Verwendung, aber eines haben sie gemeinsam. Sie sind wasserdicht und werden Dir viele Jahre lang dienen.

fr

Les produits Mardom Decor sont composés de 2 types de matériaux: le PolyForce® et le ProFoam®. Chacun d'entre eux possède ses propres caractéristiques, mais ont un point commun. Tous deux sont hermétiques et resteront en place de nombreuses années.



PolyForce®



ProFoam®

MATERIAŁY MATERIALS MATERIALIEN MATÉRIAUX	TRWAŁOŚĆ DURABILITY LANGLEBIGKEIT DURABILITÉ	GĘSTOŚĆ DENSITY DICHTÉ DENSITÉ	WODOODPORNOŚĆ WATERPROOF WASSERFEST IMPERMÉABILITÉ	DO PODŚWIETLENIA LED DEDICATED FOR LED FÜR LED GEEIGNET POSSIBILITÉ D'ÉCLAIRAGE LED	POKRYTY FARBĄ PODKŁADOWĄ PRIMED VORGRUNDIERT RECOUVERT D'UN PRIMAIRE D'ACCROCHAGE	WZÓR LISTWY MOULDING DESIGN DESIGN MODÈLE DE PLINTHE
PolyForce®	●●●●●	●●●●●	●●●●●	✓	✓	GLADKA   PLAIN   GLATT   LISSE
ProFoam®	●●●●○	●●●●○	●●●●●	✗	✓	ZDOBIONA   ORNAMENTED ORNAMEN TEN   DÉCORÉ

# Wykończenia

FINISHES | AUSFÜHRUNG | FINITIONS

## pl

Listwy przypodłogowe Mardom Decor występują w dwóch wykończeniach - standardowym matowym oraz ekskluzywnym satynowym. Mardom Decor Premium to kolekcja satynowych, wodoodpornych listew przypodłogowych, które nie wymagają malowania. Pokryte są ekskluzywną powłoką, która nadaje listwom satynowe wykończenie, idealną gładkość i śnieżną biel. Ich montaż polega tylko na przyklejeniu listwy do ściany - bez konieczności późniejszego malowania ich farbą. Listwy Mardom Decor Premium są wodoodporne, dzięki czemu możesz stosować je w łazience i kuchni. Oprócz najwyższej trwałości i funkcjonalności, listwy zachwycają pięknym wyglądem. To najwyższy poziom w wykańczaniu wnętrz. Listwy Mardom Decor Premium oznaczane są symbolem „P” np. „MD234P”.

## de

Die Sockelleisten von Mardom Decor sind in zwei Varianten erhältlich. Zum einen in Standard matt weiß vorgründert und zum anderen in der Premiumqualität. Mardom Decor Premium besitzt eine fertig lackierte, satinierte, weiße, wasserfeste Beschichtung. Somit ist keine Endlackierung notwendig. Die Oberfläche ist extrem glatt und schneeweiß im Farbton. Das heißt die Sockelleisten müssen nur montiert/geklebt werden und der Arbeitsgang „Endlackierung“ entfällt. Mardom Decor Premium ist wasserfest und somit für alle Nassräume geeignet. Kein Aufquellen wie bei herkömmlichen MDF-Produkten! Das hochwertige Erscheinungsbild, sowie die Funktionalität vereint diese Innovation zur höchsten Stufe im Premiumsektor der Raumgestaltung. Mardom Decor Premium Leisten sind mit dem Symbol „P“ gekennzeichnet. Z.B.: MD234P.

## en

Mardom Decor skirting boards come in two finishes - the standard matte and the exclusive satin. Mardom Decor Premium is a collection of satin, water-resistant skirting boards that do not require painting. They are finished with exclusive coating that gives the boards satin look, perfect smoothness and snow whiteness. Their fixture consists merely of sticking the board to the wall - with no subsequent painting needed. Mardom Decor Premium skirting boards are water-resistant, making them suitable for use in bathroom or kitchen. Adding to its exceptional durability and functionality, the product impresses with its beautiful looks. This is the premium level of interior decoration. Mardom Decor Premium boards are designated with the "P" symbol, e.g. "MD234P".

## fr

Les plinthes Mardom Decor sont disponibles en deux finitions: mate en standard et satinée exclusive. Mardom Decor Premium est une collection de plinthes satinées et imperméables qui ne nécessitent pas de peinture. Elles sont recouvertes d'un revêtement exclusif qui donne aux plinthes une finition satinée, d'une douceur parfaite et d'un blanc brillant. Leur assemblage consiste uniquement à coller la moulure au mur - sans avoir besoin de les peindre ultérieurement. Les plinthes Mardom Decor Premium sont imperméables, vous pouvez donc les utiliser dans la salle de bain et la cuisine. En plus de leur durabilité et de leur fonctionnalité des plus élevées, les plinthes apportent avec une belle apparence. Il s'agit du plus haut niveau de finition intérieure. Les plinthes Mardom Decor Premium sont marquées du symbole „P”, par exemple „MD234P”.

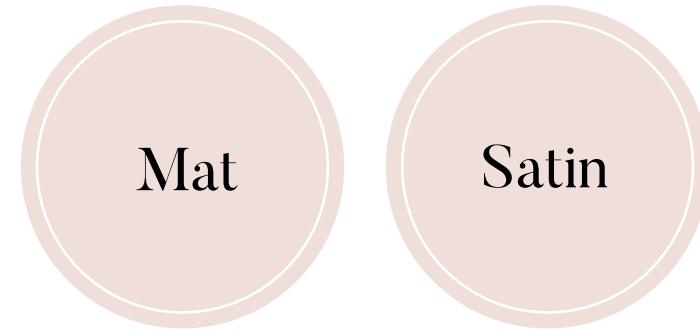

MARDOM DECOR Premium®

RODZAJ WYKOŃCZENIA MOULDING DESIGN DESIGN MODÈLE DE PLINTHE	LUKSUSOWY WYGLĄD LUXURIOUS APPEARANCE LUXURIÖSES ERSCHEINUNGSBILD ASPECT LUXUEUX	MALOWANIE PAINTING ANSTRICH LA PEINTURE	MASKOWANIE ŁĄCZEŃ FINISHING JOINTS NAHTSTELLEN MASQUAGE DES JONCTIONS
Mat	●●●○	<b>Sugerujemy pomalowanie listwy dowolną farbą na bazie wody.</b> We suggest painting the skirting board with any water-based paint. Wir empfehlen für den Endanstrich handelsübliche Farben auf Wasserbasis zu verwenden. Vous pouvez peindre la plinthe avec n'importe quelle peinture à l'eau.	<b>Użyj kleju Mardom Decor Fix Pro.</b> Use Mardom Decor Fix Pro adhesive. Verwenden Sie Mardom Fix Pro Nahtstellenkleber. Utilisez la colle Mardom Decor Fix Pro.
Satin	●●●●	<b>Nadaje się do bezpośredniego montażu.</b> Suitable for direct installation. Für den direkten Einbau geeignet. Convient pour un montage immédiat.	<b>Użyj lakieru Mardom Decor Premium.</b> Use Mardom Decor Premium lacquer. Verwenden Sie Mardom Premium-Lack. Utilisez le vernis Mardom Decor Premium.

# Legenda

MARDOM  
DECOR

	pl	en	de	fr
PolyForce®	Produkty wykonane z PolyForce® - bardzo trwałego, ekologicznego materiału o wysokiej gęstości, odpornego na uszkodzenia mechaniczne.	Products made of PolyForce® - a very durable, ecological material with high density and resistance to mechanical damage.	Produkte aus PolyForce® - einem äußerst langlebigen, asserdichten Material mit sehr hoher Dichte, das resistent gegen mechanische Beschädigungen ist.	Les Produits fabriqués à partir de PolyForce® - un matériau durable et écologique à haute résistance au poinçonnement.
ProFoam®	Produkty wykonane z ProFoam® - twardego i jednocześnie lekkiego materiału o gęstości umożliwiającej tworzenie ostrych i głębokich zdobień.	Products made of ProFoam® - a hard yet lightweight material with a density enabling the creation of sharp and deep adornments.	Produkte aus ProFoam® - einem festen und dennoch leichtem Material mit einer Dichte, die die Herstellung von scharfen und tiefen Verzierungen ermöglicht.	Produits fabriqués à partir de ProFoam® - dense et léger permettant la création de décorations aux reliefs précis et profonds.
ScratchShield®	Listwy przypodłogowe poddawane są wielu codziennym wyzwaniom. Doskonale to wiemy. Właśnie dlatego, opracowaliśmy innowacyjną technologię ScratchShield, która polega na ekstremalnym utwardzeniu listwy przypodłogowej. Różnica jest ogromna i zauważalna przy próbie zarysowania listwy ostrym narzędziem. Twardość listew z technologią ScratchShield jest o 24% większa niż standardowych listew. Pomiar twardości wykonywany jest twardościomierzem i wyrażony w skali Shore'a.	Skirting boards are subject to many daily challenges. We know this perfectly well. That's why we have developed the innovative ScratchShield technology, which consists in extremely hardening our skirting boards. The difference is huge and noticeable when trying to scratch the skirting board with a sharp tool. The hardness of skirting boards with ScratchShield technology is 24% higher than standard skirting boards. The hardness is measured with a hardness meter and expressed in Shore scale.	Sockelleisten sind im Alltag vielen Herausforderungen ausgesetzt. Das wissen wir ganz genau. Deshalb haben wir die innovative ScratchShield-Technologie entwickelt, die darin besteht, unsere Sockelleisten extrem zu härten. Der Unterschied ist sofort spürbar, wenn man versucht, die Sockelleiste mit einem scharfen Werkzeug zu zerkratzen. Die Härte der Sockelleisten mit ScratchShield-Technologie ist 24 % höher als die von Standard-Sockelleisten. Die Härte wird mit einem Härtemessgerät gemessen und in der Shore-Skala angegeben.	Les plinthes font face à de nombreux défis quotidiens. Nous le savons parfaitement bien. C'est pourquoi nous avons développé la technologie innovante ScratchShield, qui repose sur le durcissement extrême de la plinthe. La différence est énorme et perceptible lorsque vous essayez de gratter la plinthe avec un outil pointu. La dureté des lames dotées de la technologie ScratchShield est 24% supérieure à celle des lames standard. La mesure de la dureté est réalisée avec un duromètre et exprimée sur l'échelle Shore.
LightGuard®	Listwy oświetleniowe Mardom Decor posiadają unikalną technologię LightGuard® zapobiegającą przebijaniu światła przez powierzchnię listwy.	Mardom Decor lighting moldings feature the unique LightGuard® technology that completely eliminates the piercing of LED light through the molding surface.	Mardom Decor Profile für indirekte Beleuchtung sind mit der einzigartigen LightGuard®-Technologie ausgestattet, die das Durchdringen des LED-Lichts durch die Leistenoberfläche vollständig verhindert.	Les moules d'éclairage Mardom Decor sont dotées de la technologie unique LightGuard® qui élimine complètement le perçage de la lumière LED à travers la surface des moules.
Flex	Produkt dostępny w wersji elastycznej, przeznaczony do stosowania na półokrągłych lub nierównych ścianach. Listwy Flex mają długość 200 cm.	Product available in the flexible version, intended for use on half-rounded or uneven walls. The Flex mouldings have a length of 200 cm.	Das Produkt ist in flexibler Ausführung erhältlich und für den Einsatz an halbrunden oder unebenen Wänden vorgesehen. Flexible Leisten sind 200 cm lang.	Produit disponible en version flexible, à utiliser sur des murs courbes ou irréguliers. Les lattes flexibles mesurent 200 cm de long.
MULTIFUNCTIONAL	Profil multifunkcyjny, którego kształt umożliwia montaż w różnych wariantach: jako listwa przypodłogowa, ścienna i sufitowa.	A multifunctional profile that enables installation in various variants: as a skirting, wall moulding and cornice moulding.	Ein multifunktionales Profil, das den Einbau in verschiedenen Anwendungen ermöglicht: z. B. als Sockelleiste, Wandleiste, Deckenleiste.	Un profilé multifonctions dont la forme permet un montage dans diverses versions : en tant que plinthe de sol et murale et comme moulure de plafond.



# Listwy elastyczne

FLEXIBLE MOULDINGS | FLEXIBLE LEISTEN | MOULURES SOUPLES

pl

**Potrzebujesz zamontować listwę na półokrągłej ścianie? Nierówności uniemożliwiają Ci montaż prostej listwy? W takich sytuacjach najlepiej sprawdzą się listwy elastyczne. Wykonane są ze specjalnego, giętkiego tworzywa. Listwy malujemy dopiero po zamontowaniu, po to, aby uniknąć popękania powłoki farby.**

en

Do you need to install the moulding on a semicircular wall? Unevenness prevents you from installing a straight moulding? In such situations, flexible profiles are the best solution. They are made of a special, flexible material. The mouldings should be painted only after installation in order to avoid cracking of the paint coating.

de

Möchten Sie Profileleisten an einer halbrunden Wand montieren oder Unebenheiten verhindern, dass Sie diese einfach anbringen lassen? In solchen Situationen sind flexible Profileisten die beste Lösung. Sie sind aus einem speziellen, flexiblen Material gefertigt und können jede Rundung problemlos nachformen. Sie lassen sich bis 90° im Innen- oder Außen-Eck anbringen. Flexible Profileisten sollten erst nach der Montage gestrichen werden, um Risse in der Lackschicht zu vermeiden.

fr

Avez-vous besoin de monter une moulure sur un mur semi-circulaire? Des irrégularités vous empêchent d'installer une moulure droite? Les moulures flexibles sont la meilleure solution dans de telles situations. Elles sont fabriquées dans un matériau spécial et flexible. Nous ne peignons les bandes qu'après l'installation afin d'éviter de fissurer le revêtement de peinture.



# Technologia LightGuard®

LIGHTGUARD® TECHNOLOGY | LIGHTGUARD® TECHNOLOGIE | TECHNOLOGIE LIGHTGUARD®

pl

**Listwy oświetleniowe Mardom Decor posiadają unikalną technologię LightGuard® zapobiegającą przebijaniu światła przez powierzchnię listwy. Efekt przebijania światła jest zjawiskiem naturalnym, jednak znacznie wpływającym na niekorzystny efekt wizualny podświetlonej listwy. Do tej pory, aby go wyeliminować, konieczne było oklejanie listwy od wewnętrznej strony taśmą aluminiową. Listwy z technologią LightGuard® całkowicie rozwiązały ten problem. Światło idealnie rozprasza się wokół listwy, bez punktowych widocznych przebiegów na jej powierzchni.**

en

Mardom Decor lighting moldings feature the unique LightGuard® technology that completely eliminates the piercing of LED light through the molding surface. The effect of light piercing is a normal phenomenon, but significantly affects the adverse visual effect of the illuminated molding. Until now, in order to eliminate it, it was necessary to tape the molding on the inside with aluminium tape. Moldings with LightGuard® technology have completely solved this problem. The light is perfectly dispersed around the molding and does not shine through anywhere on its surface.

de

Profile für indirekte Beleuchtung von Mardom Decor zeichnen sich durch die einzigartige LightGuard® Technologie aus. Bisher mussten Profile für indirekte Beleuchtung mit einem Aluminiumband versehen werden, um das Durchscheinen der Lichtquelle zu vermeiden. Dieses Aluminiumband ist nicht nur aus umweltverträglichen Gesichtspunkten bedenklich, sondern in erster Linie auch ein zusätzlich zeitraubender Arbeitsaufwand. Nur Produkte von Mardom Decor sind mit LightGuard® hergestellt und verhindern, dass Lichtpunkte die Oberflächenstruktur durchdringen. Das Licht wird gleichmäßig gestreut.

fr

Les moulures d'éclairage Mardom Decor sont dotées de la technologie unique LightGuard® qui élimine complètement le perçage de la lumière LED à travers la surface des moulures. L'effet du perçage de la lumière est un phénomène normal, mais affecte défavorablement l'effet visuel des moulures d'éclairage. Jusqu'à présent, pour l'éliminer, il était nécessaire de coller à l'intérieur de la moulure un ruban aluminium. La technologie LightGuard® a complètement résolu ce problème. La lumière est parfaitement dispersée autour de la moulure et ne brille nulle part sur sa surface.



# Dlaczego warto wybrać listwy Mardom Decor?

WHY CHOOSE MARDOM DECOR MOULDINGS? | WARUM MARDOM DECOR PROFILE WÄHLEN? | POURQUOI CHOISIR LES PLINTHES MARDOM DECOR?



## ŁATWY MONTAŻ

EASE OF INSTALLATION | EINFACHE MONTAGE | LEICHTE MONTAGE



## POKRYTE PRIMEREM

COVERED WITH PRIMER | MIT GRUNDIERUNG VERSEHEN  
RECOUVERT D'UN PRIMAIRE D'ACCROCHAGE

**pl**

**Produkty są łatwe w obróbce i montażu. Mardom Decor oferuje akcesoria dodatkowo ułatwiające ten proces.**

**en**

The products are easy to cut and install. Mardom Decor offers accessories that facilitate this process.

**de**

Die Produkte sind leicht zuzuschneiden und zu verlegen. Mardom Decor bietet Zubehör, das diesen Prozess erleichtert.

**fr**

Les produits sont faciles à utiliser et à installer. Mardom Decor propose des accessoires qui facilitent davantage la pose.

**pl**

**Wszystkie listwy pokryte są specjalnym, zabezpieczającym primerem, ułatwiającym absorpcję farby.**

**en**

All mouldings are covered with a special protective primer, which facilitates paint absorption.

**de**

Alle Leisten sind mit einer speziellen Schutzgrundierung versehen, die die Farbaufnahme erleichtert.

**fr**

Toutes les moulures sont recouvertes d'un primaire d'accrochage spéciale, facilitant l'absorption de peinture.

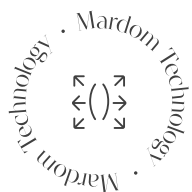

## ODPORNE NA PĘCZNIENIE

SWELLING RESISTANCE | QUELLBESTÄNDIGKEIT | RÉSISTANCE À LA DILATATION

**pl**

Listwy Mardom Decor, w przeciwieństwie do listew wykonanych z MDF, nie ulegają odkształcaniu, rozwarstwianiu i pęcznieniu pod wpływem wilgoci.

**de**

Mardom Decor Profile unterliegen im Gegensatz zu MDF-Produkten keiner Verformung, Delaminierung oder Aufquellen unter dem Einfluss von Feuchtigkeit.

**en**

Mardom Decor mouldings, unlike MDF products, do not undergo deformation, delamination and swelling under the influence of moisture.

**fr**

Les moulures Mardom Decor, contrairement aux moulures en MDF, ne se déforme et dilatent pas sous l'effet de l'humidité.



## WODOODPORNE MATERIAŁY

EWATERPROOF MATERIALS | WASSERFESTES MATERIAL | MATÉRIAUX IMPERMÉABLES

**pl**

Produkty są wodoodporne, dlatego mogą być montowane w pomieszczeniach o podwyższonej wilgotności.

**de**

Die Produkte sind wasserfest, so dass sie auch in Räumen mit hoher Luftfeuchtigkeit eingesetzt werden können.

**en**

The products are waterproof, so they can be installed in rooms with increased humidity.

**fr**

Les produits sont hermétiques, et peuvent donc être montés dans des pièces humides.



1. MD003

2. MD325

3. MD346

4. MDB117

5. MD356



MARDOM  
DECOR

*Atelier*<sup>®</sup>

**pl**

**Mardom Decor Atelier jest odpowiedzią na wyjątkowe potrzeby naszych klientów, dla których opracowujemy oryginalne i innowacyjne projekty. Elastycznie dostosowujemy się do indywidualnych wizji i oczekiwań, tworząc sztukaterię skrojoną na Twoją miarę. Masz pomysł na autorski kształt listwy? Chcesz pomalować listwę na dowolny kolor z wzornika NCS? Wykonamy to dla Ciebie!**

**de**

Mardom Decor Atelier ist die Antwort auf die außergewöhnlichen Anforderungen für Planer und Architekten. Sie planen individuelle und innovative Projekte und haben eine genaue Vorstellung wie Ihre Leisten aussehen sollen? Wir können Ihre Entwürfe auf Anfrage realisieren. Gerne lackieren wir ab einer bestimmten Menge Ihre Leisten in jedem beliebigen Farbton aus der NCS-Farbtonpalette.

**en**

Mardom Decor Atelier responds to the individual needs of our customers for whom we develop original and innovative designs. We aim at adapting to the vision and expectations of the clients, creating stuccowork tailored to your needs. Do you have an idea for the original shape of the molding? Do you want to paint the molding in any color from the NCS palette? We will do it for you!

**fr**

Mardom Decor Atelier est une réponse aux besoins uniques de nos clients, pour lesquels nous développons des projets originaux et innovants. Nous nous adaptons avec souplesse aux visions et attentes individuelles, en créant des moulures adaptées à vos besoins. Vous avez une idée pour une forme originale de moulures ? Vous voulez peindre la moulure dans n'importe quelle couleur du nuancier NCS? Nous le ferons pour vous!



# Listwy karniszowe

CURTAIN PROFILES | GARDINENBLENDEN | LES CORNICHES

**pl**

**Mardom Decor jako pierwsza firma na rynku zaprojektowała i stworzyła kolekcję listew karniszowych, które stały się ulubionym produktem architektów, projektantów oraz klientów indywidualnych. Posiadamy największy na rynku wybór wzorów, dlatego liczymy, że u nas odnajdą Państwo produkt odpowiedni dla siebie.**

**de**

Mardom Decor war das erste Unternehmen auf dem Markt, das eine Kollektion von Gardinenblenden entwarf und produzierte, die sich zu einem sehr beliebten Produkt für Architekten, Designer und Privatkunden entwickelte. Wir haben die größte Auswahl an Designs am Markt und sind überzeugt, dass auch Sie das richtige Produkt für sich finden.

**en**

Mardom Decor was the first to introduce curtain system solution in the World, which has become the top choice of architects, designers and private customers. In our offer we have the widest selection of products which will for sure fulfil your needs.

**fr**

Mardom Decor a été la première entreprise sur le marché à concevoir et créer une collection de corniches cache tringles à rideaux, qui sont devenues un des produits préférés des architectes, des designers et des clients particuliers. Nous possédons la plus grande sélection de modèles sur le marché, nous espérons donc que vous trouverez le produit qui vous convient.

1. QL036

**INNOWACYJNE ROZWIĄZANIE DLA OŚWIETLENIA LED**

INNOVATIVE SOLUTION FOR LED LIGHTING

INNOVATIVE LÖSUNG FÜR INDIREKTE BELEUCHTUNG

SOLUTION INNOVANTE POUR L'ÉCLAIRAGE LED

**pl**

**Kształt listew pozwala na umieszczenie w specjalnie zaprojektowanej wnęce taśmy LED. Dzięki temu listwa łączy funkcję maskowania karnisza z oświetleniem pomieszczenia.**

**en**

Profiles have been designed to be equipped with LED strips which gives you nice ambient effect.

**fr**

La forme des moulures vous permet de placer une bande LED dans un renforcement spécialement conçu. Grâce à cela, la bande combine la fonction de masquage de la tringle à rideau avec l'éclairage de la pièce.

**de**

Die Profile sind so konzipiert, dass sie mit LED-Streifen beklebt werden können, um einen angenehmen Wohlfühl-Effekt zu erzeugen.

**OSZCZĘDNOŚĆ CZASU I OBNIŻENIE KOSZTÓW REMONTU**

REDUCTION OF TIME AND COST DURING FURNISHING OF INTERIORS

REDUZIERUNG DES ZEIT- UND KOSTENAUFWANDS

GAIN DE TEMPS ET REDUCTION DU COUT DU SECOND OEUVRE

**pl**

**Montaż polega na docięciu listwy do określonego wymiaru oraz przyklejeniu jej do sufitu.**

**en**

Easy to install by just cutting up to measure and gluing of the profile to the ceiling.

**de**

Einfache Montage durch Zuschnitt auf Maß und Verklebung des Profils mit der Decke.

**fr**

L'installation consiste à couper la moulure à une taille spécifique et à la coller au plafond.

**ZASTOSOWANIE PRYWATNE I KOMERCYJNE**

PRIVATE AND COMMERCIAL USE

PRIVATE UND KOMMERZIELLE NUTZUNG

UTILISATION PRIVÉE ET COMMERCIALE

**pl**

**Zróznicowaliśmy wielkość listew w taki sposób, aby sprawdzały się we wszystkich typach pomieszczeń - mieszkaniach, kamienicach, loftach, pokojach hotelowych.**

**en**

Wide offer of products gives opportunities to use them in various interiors: residential, commercial.

**fr**

Nous avons diversifié les dimensions des moulures de manière à ce qu'elles s'adaptent à tous types de pièces - appartements, immeubles, lofts, chambres d'hôtel.

**de**

Wir haben die Größe der Profileisten so variiert, dass sie für alle Arten von Räumlichkeiten geeignet sind - Wohnungen, Stadthäuser, Lofts und Hotelzimmer.

**NAJWYŻSZA JAKOŚĆ**

HIGHEST QUALITY

HÖCHSTE QUALITÄT

LA PLUS HAUTE QUALITÉ

**pl**

**Użycie najwyższej jakości surowców przekłada się na gęstość i odporność listew. Listwy produkowane są w fabryce w Łodzi - dlatego czujemy nad każdym etapem produkcyjnym, eliminując wady i nieprawidłowości.**

**en**

Profiles are manufactured with highest quality standard and with use of best possible raw materials in our factory in Poland. That is why we control every stage of production, eliminating defects and irregularities.

**de**

Die Profile werden mit höchstem Qualitätsstandard und unter Verwendung bester Rohstoffe in unserem Werk in Lodz (Polen) hergestellt. Deshalb kontrollieren wir jede Produktionsphase und beseitigen Mängel und Unregelmäßigkeiten.

**fr**

L'utilisation de matières premières de la plus haute qualité se traduit par la densité et la résistance des moulures. Les moulures sont fabriquées dans notre usine de Łódź - c'est pourquoi nous surveillons chaque étape de la production, éliminant les défauts et les irrégularités.

Listwy karniszowe · Curtain profiles



**MD213**  
MULTIFUNCTIONAL

PolyForce®



200 x 8,1 x 8,1 cm



**MD111**  
MULTIFUNCTIONAL

PolyForce®



200 x 9,2 x 6,2 cm

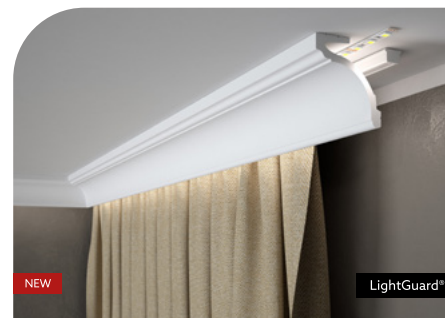

**MD161**  
MULTIFUNCTIONAL

PolyForce®



200 x 9,2 x 8,3 cm



**QL011**  
MULTIFUNCTIONAL

PolyForce®



200 x 9,5 x 12,3 cm



**MD137**  
MULTIFUNCTIONAL

PolyForce®



200 x 9,6 x 5,5 cm

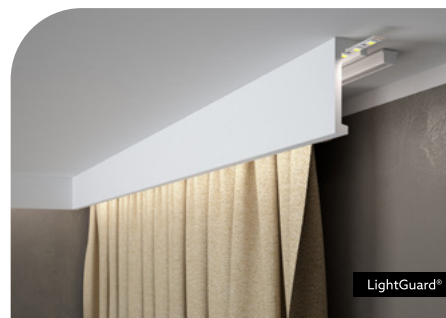

**QL026**

PolyForce®



240 x 10 x 4,1 cm

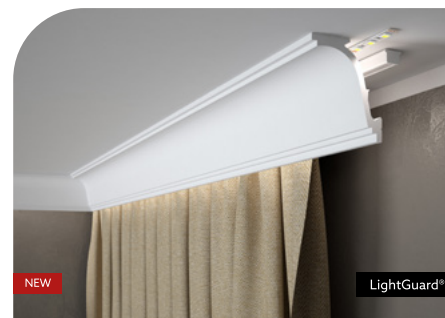

**MD110**  
MULTIFUNCTIONAL

PolyForce®



200 x 10,6 x 8,9 cm



**MD105**  
MULTIFUNCTIONAL

PolyForce®



200 x 10,8 x 12 cm





**QL027**  
MULTIFUNCTIONAL



PolyForce®

200 x 11 x 11 cm

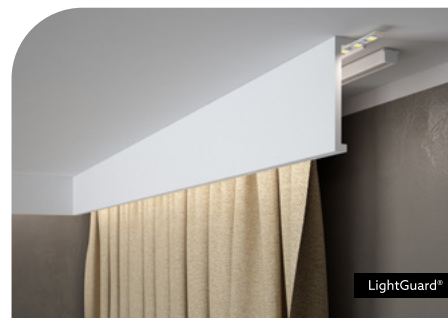

**QL035**



PolyForce®

240 x 12 x 4 cm

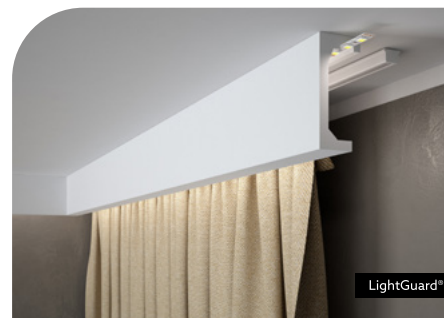

**QL046**



PolyForce®

240 x 12 x 5 cm



**MD156**  
MULTIFUNCTIONAL



PolyForce®

200 x 14,5 x 11 cm



**QL036**



PolyForce®

240 x 14,8 x 4,6 cm

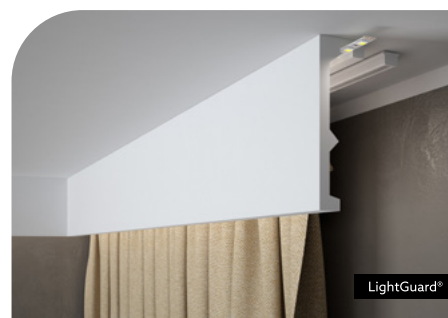

**QL056**



PolyForce®

240 x 17,9 x 5,5 cm

# Listwy przypodłogowe

SKIRTING | SOCKELLEISTEN | PLINTHES BLANCHES

Mardom Quality · Mardom Quality · Mardom Quality

## pl

Listwy przypodłogowe to niezbędny element każdego wnętrza. Stanowią estetyczne wykończenie pomiędzy podłogą, a ścianą. Podczas wyboru, warto kierować się zarówno pięknym wyglądem listwy, jak i funkcjonalnością. Nasze listwy przypodłogowe wykonane są z niezwykle trwałego materiału PolyForce®, dzięki czemu są odporne na uszkodzenia i działanie wody. Posiadają też specjalne przestrzenie na ukrycie przewodów i kabli. Listwy pokryte są primerem, który ułatwia rozprowadzanie i wchłanianie kolejnych warstw farby. Jeśli poszukujesz listwy gotowej do bezpośredniego montażu, wybierz produkt z kolekcji Mardom Decor Premium - pokryty ekskluzywnym, satynowym lakierem, niewymagającym malowania listwy farbą.

## de

Sockelleisten sind ein essenzieller Bestandteil und nicht mehr wegzudenken aus jedem Innenraum. Sie sind die ästhetische Vollendung zwischen Fußboden und Wand. Bei der Auswahl sollte man sich nicht nur nach dem Design, sondern auch nach der Funktionalität orientieren. Unsere Sockelleisten sind aus dem langlebigen Material PolyForce® hergestellt. Dank diesem Material sind unsere Sockelleisten besonders widerstandsfähig gegen Beschädigungen und Feuchtigkeit. Sie besitzen auch zusätzlich einen Hohlraum zur Verdeckung von Leitungen und Kabel. Unsere Leisten sind bereits vorgrundiert, um das Auftragen der Endlackierung zu erleichtern. Sollten Sie eine montagefertige Leiste suchen, bieten wir in der Kollektion Mardom Decor Premium bereits die endlackierten Leisten an. Diese sind mit einem exklusiven und satinierten Lack beschichtet und eignen sich zur sofortigen Montage.

1. MD095

## en

Skirting boards are an essential element of any interior. They create an aesthetic finish between the floor and the wall. When choosing a skirting board, it is worth taking into account both its appearance and functionality. Our skirting boards are made of extremely durable PolyForce® material ensuring their resistance to damage and water. They also have special spaces for concealing wires and cables. The boards are treated with a primer, which facilitates the application and absorption of subsequent layers of paint. If you are looking for a skirting board for direct installation, choose a product from the Mardom Decor Premium collection - coated with an exclusive satin varnish, which does not require painting the board.

## fr

Les plinthes sont des éléments indispensables de tout intérieur. Elles offrent une finition esthétique entre le sol et le mur. Lors de votre choix, il convient de considérer à la fois la belle apparence de la plinthe et sa fonctionnalité. Nos plinthes sont fabriquées en matériau PolyForce® extrêmement durable, ce qui les rend résistantes au poinçonnement et à l'humidité. Elles ont également des espaces spéciaux pour cacher les fils et les câbles. Les plinthes sont recouvertes d'un apprêt, ce qui facilite la distribution et l'absorption des couches de peinture suivantes. Si vous recherchez une plinthe prête pour une installation directe, choisissez un produit de la collection Mardom Decor Premium - recouvert d'un vernis satiné exclusif, qui ne nécessite pas de peindre la plinthe avec de la peinture.

1



MD235 mat  
MD235P satin



PolyForce® | ScratchShield® 200 x 1,8 x 1,8 cm



QL021 mat  
QL021P satin



PolyForce® | ScratchShield® 200 x 2 x 2,5 cm



MD001 mat  
MD001P satin



PolyForce® | ScratchShield® 200 x 2,1 x 2,1 cm



MD011 mat  
MD011P satin



PolyForce® | ScratchShield® 200 x 4 x 1 cm



MD004 mat  
MD004P satin



PolyForce® | ScratchShield® 200 x 4,9 x 1,5 cm



MD027 mat  
MD027P satin



PolyForce® | ScratchShield® 200 x 6 x 1,3 cm



MD028 mat  
MD028P satin



PolyForce® | ScratchShield® 200 x 6 x 1,3 cm



MD017 mat  
MD017P satin



PolyForce® | ScratchShield® 200 x 6,9 x 1,4 cm



MD359 mat  
MD359P satin  
MD359B black

PolyForce® | ScratchShield®  
Flex (MD359F)

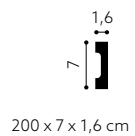

MD234 mat  
MD234P satin

PolyForce® | ScratchShield®  
Flex (MD234F)

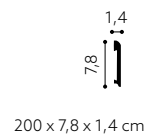

MD018 mat  
MD018P satin

PolyForce® | ScratchShield®  
Flex (MD018F)

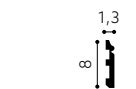

MD014 mat  
MD014P satin

PolyForce® | ScratchShield®

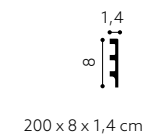

QL019 mat  
QL019P satin

PolyForce® | ScratchShield®

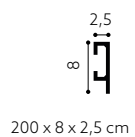

MD024 mat  
MD024P satin

PolyForce® | ScratchShield®

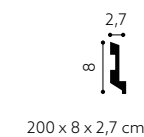

MD008 mat  
MD008P satin

PolyForce® | ScratchShield®

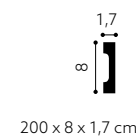

MD258 mat  
MD258P satin

PolyForce® | ScratchShield®

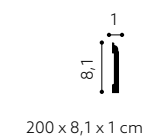



MD8300 mat  
MD8300P satin



PolyForce® | ScratchShield® 200 x 8,2 x 2,6 cm



QL007 mat  
QL007P satin



PolyForce® | ScratchShield® 200 x 9,3 x 4 cm



MD094 mat  
MD094P satin



PolyForce® | ScratchShield® 200 x 9,4 x 1,2 cm



MD355 mat  
MD355P satin



PolyForce® | ScratchShield®  
Flex (MD355F) 200 x 9,7 x 1,8 cm



MD236 mat  
MD236P satin



PolyForce® | ScratchShield® 200 x 9,9 x 1,3 cm



QS009 mat  
QS009P satin



PolyForce® | ScratchShield® 200 x 10 x 1,6 cm



MD009 mat  
MD009P satin



PolyForce® | ScratchShield® 200 x 10 x 1,7 cm



MD013 mat  
MD013P satin



PolyForce® | ScratchShield® 200 x 10 x 1 cm



MD016 mat  
MD016P satin



PolyForce® | ScratchShield® 200 x 10 x 2,3 cm



MD006 mat  
MD006P satin  
Wymiary wnęki | Niche dimensions | Einbautiefe  
Les dimensions du renforcement: 1,3 x 8,8 cm



PolyForce® 200 x 10,1 x 2,3 cm



MD363 mat  
MD363P satin



PolyForce® | ScratchShield® 200 x 10,6 x 2,3 cm



MD354 mat  
MD354P satin



PolyForce® | ScratchShield® 200 x 10,7 x 1,1 cm



QS004 mat  
QS004P satin



PolyForce® | ScratchShield® 200 x 10,8 x 1,5 cm



MD356 mat  
MD356P satin



PolyForce® | ScratchShield® Flex (MD356F) 200 x 10,8 x 1,6 cm



MD025 mat  
MD025P satin



PolyForce® | ScratchShield® 200 x 11 x 2,7 cm



MD005 mat  
MD005P satin  
Wymiary wnęki | Niche dimensions | Einbautiefe  
Les dimensions du renforcement: 1,7 x 9,8 cm



PolyForce® 200 x 11 x 2,2 cm



MD358 mat  
MD358P satin

PolyForce® | ScratchShield®  
Flex (MD358F)

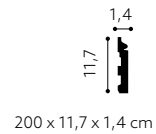

MD095 mat  
MD095P satin

PolyForce® | ScratchShield®

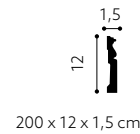

QS003 mat  
QS003P satin

PolyForce® | ScratchShield®

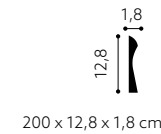

QS011 mat  
QS011P satin

PolyForce® | ScratchShield®

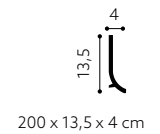

MD360 mat  
MD360P satin

PolyForce® | ScratchShield®  
Flex (MD360F)

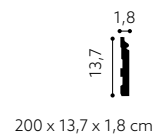

QL019 + QL021 mat  
QL019P + QL021P satin

PolyForce® | ScratchShield®  
QL019 200 x 8 x 2,5 cm  
QL021 200 x 2 x 2,5 cm



MD361 mat  
MD361P satin

PolyForce® | ScratchShield®

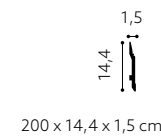

MD020 mat  
MD020P satin

PolyForce® | ScratchShield®

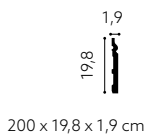

# Listwy ścienne

WALL MOULDINGS | WANDPROFILE | LES MOULURES MURALES

## pl

Listwy ścienne służą do tworzenia różnorodnych dekoracji ściennych. Małe listwy najlepiej sprawdzą się w formie ramek i paneli ściennych. Większe profile będą odpowiednie do stworzenia odcień na ścianie. Listwy ścienne wykonane są z dwóch typów materiału: PolyForce® oraz ProFoam®. Listwy wykonane z PolyForce® cechują się najwyższą odpornością na uszkodzenia. Tworzywo ProFoam® daje możliwość tworzenia wyraźnych i głębokich zdobień. Wszystkie listwy są wodoodporne, dzięki czemu mogą być stosowane w łazienkach i kuchniach. W katalogu znajdziesz wiele inspiracji do wykorzystania listew ściennych w swoim domu.

## de

Unsere Wandleisten dienen zur vielfältigen Gestaltung verschiedenster Wanddekorationen. Kleine Leisten eignen sich vor allem zur Anfertigung von Rahmen und Wandpaneelen. Größere Profile eignen sich zur Höhenabtrennung an einer hohen Wand. Mardom Decor Wandleisten bestehen aus zwei Materialtypen: PolyForce® und ProFoam®. Leisten, die aus PolyForce® angefertigt sind, zeichnen sich durch besondere Unempfindlichkeit gegen Stöße/Beschädigungen aus. ProFoam® hingegen ermöglicht, klare und tiefe Verzierungen zu schaffen. Alle Leisten sind wasserabweisend und können somit auch in Bädern und Küchen verwendet werden. Im Katalog finden Sie einige Inspirationen zur Verwendung von Mardom Decor Wandleisten für Ihr Zuhause.

## en

Wall mouldings are used to create various wall decorations. Small mouldings will work best in the form of wall frames and panels. Larger mouldings will be suitable for separating sections of the wall. Wall mouldings are made of two types of material: PolyForce® and ProFoam®. Mouldings made of PolyForce® are characterised by the highest resistance to damage. ProFoam® offers the opportunity to create clear and deep-cut decorations. All mouldings are waterproof, making them suitable for use in bathrooms and kitchens. Our catalogue contains numerous inspiring ideas for using wall mouldings in your home.

## fr

Les moulures murales sont utilisées pour créer une variété de décorations murales. Les petites moulures s'adaptent mieux pour une forme de cadres et de panneaux muraux. Des profils plus grands conviendront à la création de découpes murales. Les moulures murales sont constituées de deux types de matériaux: PolyForce® et ProFoam®. Les plinthes en PolyForce® se caractérisent par la plus haute résistance au poinçonnement. Le matériau ProFoam® vous permet de créer des décorations claires et profondes. Toutes les moulures sont étanches, elles peuvent donc être utilisées dans les salles de bain et les cuisines. Dans le catalogue, vous trouverez beaucoup d'inspiration pour l'utilisation de moulures murales dans votre maison.

1. MD360

2. MD002

3. MD413

4. MD325





MDD316



ProFoam®

200 x 1,5 x 0,5 cm



MD010



PolyForce® | ScratchShield®

200 x 1,5 x 1,5 cm

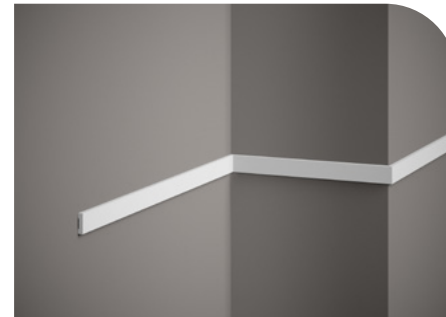

MD012



PolyForce® | ScratchShield®

200 x 2 x 0,5 cm



QL022



PolyForce® | ScratchShield®

200 x 2 x 1 cm



MD003



PolyForce® | ScratchShield®

200 x 2,2 x 1 cm



MD413



PolyForce® | ScratchShield®

200 x 2,5 x 1,2 cm



MD318



PolyForce® | ScratchShield®

200 x 3,3 x 1,5 cm



MD255



PolyForce® | ScratchShield®

200 x 3,9 x 2 cm



MD002



PolyForce® | ScratchShield® 200 x 4 x 1,8 cm



QL023



PolyForce® | ScratchShield® 200 x 4 x 1,9 cm



MD325



PolyForce® | ScratchShield® Flex (MD325F) 200 x 4,1 x 1,5 cm



MDD332



ProFoam® | Flex (MDD332F) 200 x 4,1 x 1,7 cm



MD026



PolyForce® | ScratchShield® 200 x 4,5 x 1,5 cm



MD317



PolyForce® | ScratchShield® 200 x 4,5 x 1,5 cm



MDD414



ProFoam® | Flex (MDD414F) 200 x 5,1 x 1,1 cm



MD314



PolyForce® | ScratchShield® Flex (MD314F) 200 x 5,2 x 1,7 cm



MD346

PolyForce® | ScratchShield®  
Flex (MDD346F)

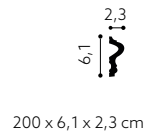

MD308

PolyForce® | ScratchShield®  
Flex (MD308F)

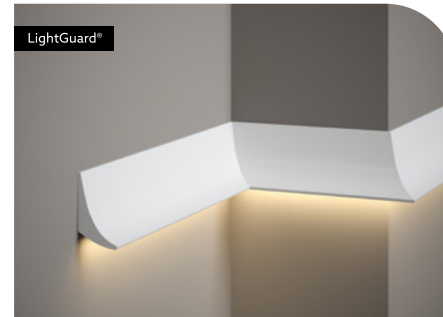
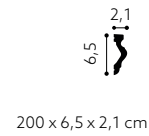

QL006

PolyForce® | ScratchShield®

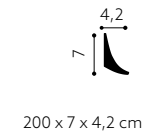

MD007

PolyForce® | ScratchShield®

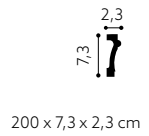

MDD412

ProFoam®

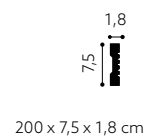

MDD351

ProFoam®

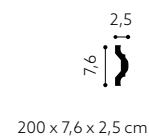

MD024

PolyForce® | ScratchShield®

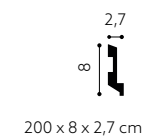

QL019

PolyForce® | ScratchShield®

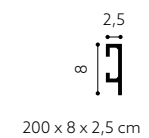



MDD338



ProFoam® | Flex (MDD338F) 200 x 8 x 2,1 cm



MDD339



ProFoam® | Flex (MDD339F) 200 x 8,1 x 1,9 cm



MDD311



ProFoam® 200 x 8,5 x 2,5 cm



MDD305



ProFoam® 200 x 9 x 3 cm

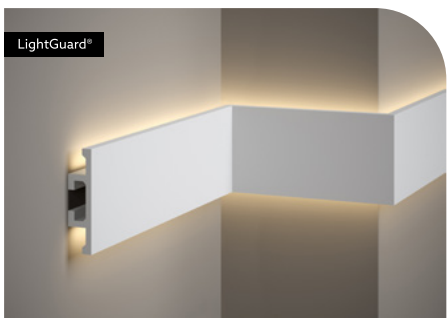

QL017



PolyForce® | ScratchShield® 200 x 10 x 2,5 cm

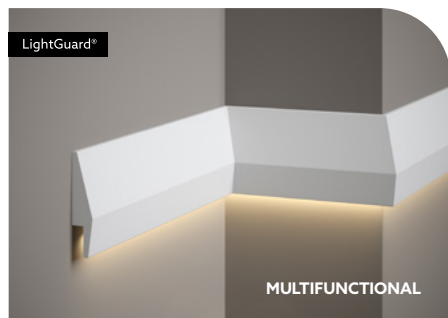

MD016



PolyForce® | ScratchShield® 200 x 10 x 2,3 cm



MDD334



ProFoam® 200 x 10,1 x 3,3 cm



MDD345



ProFoam® | Flex (MDD345F) 200 x 10,2 x 2,4 cm



MDD410



ProFoam® 200 x 10,8 x 2 cm

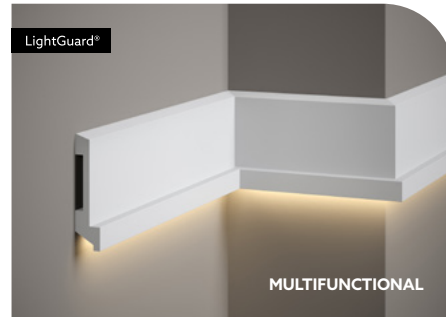

MD025



PolyForce® | ScratchShield® 200 x 11 x 2,7 cm

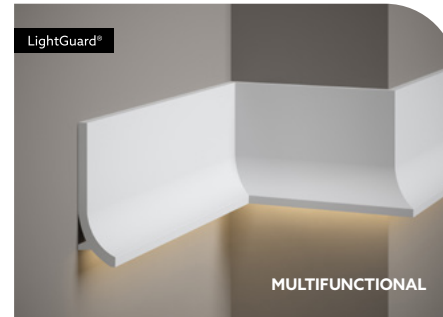

QS011



PolyForce® | ScratchShield® 200 x 13,5 x 4 cm



MDD335



ProFoam® 200 x 15,5 x 5,4 cm

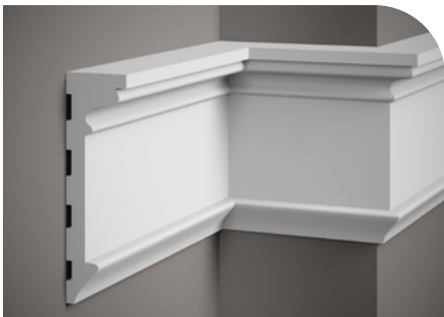

MDD315



ProFoam® 200 x 22 x 6,6 cm



MD237



PolyForce® | ScratchShield® 200 x 3 x 3 cm



MDB123



ProFoam® 200 x 4 x 4 cm

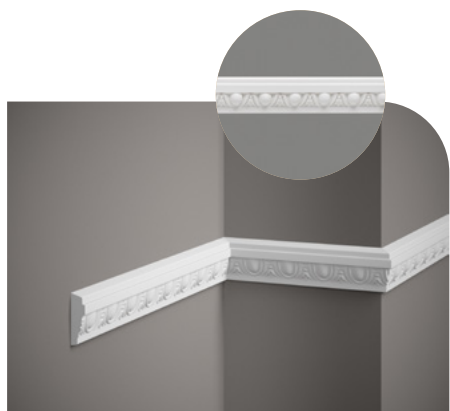

MDC255



ProFoam®

200 x 5 x 1,6 cm

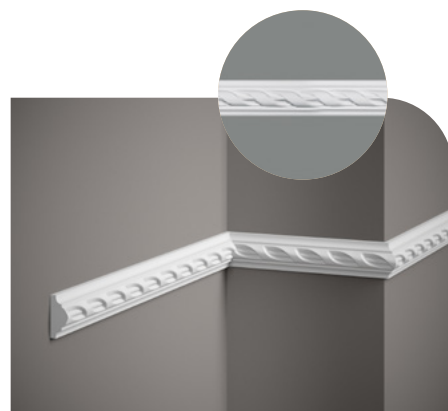

MDC252



ProFoam® | Flex (MDC252F)

200 x 5,4 x 2,3 cm

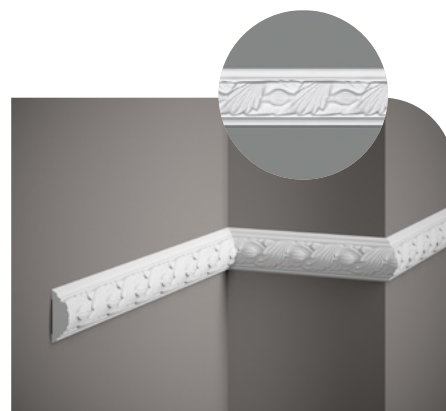

MDC258



ProFoam® | Flex (MDC258F)

200 x 5,4 x 2 cm

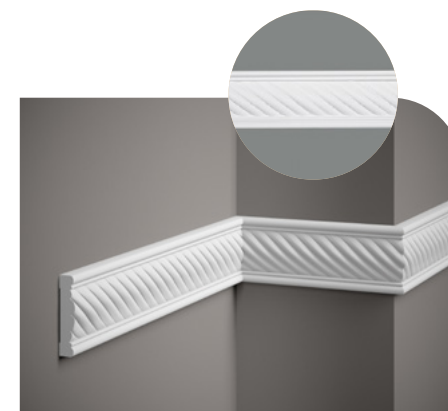

MDC239



ProFoam® | Flex (MDC239F)

200 x 7,5 x 1,5 cm

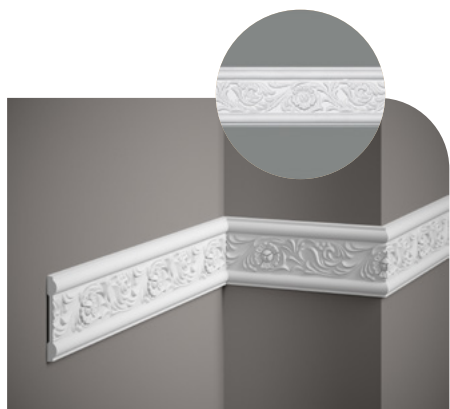

MDC217



ProFoam® | Flex (MDC217F)

200 x 7,8 x 1,3 cm

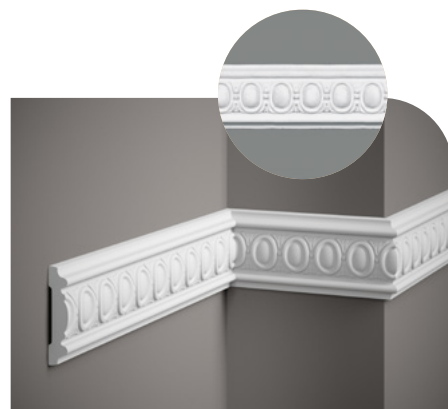

MDC250



ProFoam® | Flex (MDC250F)

200 x 8,1 x 1,5 cm



MDC236



ProFoam® | Flex (MDC236F)

200 x 12,8 x 1,4 cm



- 1. MD020
- 2. MDC252-II
- 3. MDD338
- 4. MDC252
- 5. MDB135
- 6. QL036

# Listwy sufitowe

CORNICE MOULDINGS | DECKENLEISTEN | LES MOULURES DE PLAFOND

**pl**

**Listwy sufitowe to element dekoracyjny, który może całkowicie odmienić Twoje wnętrze. Listwy wykonane są z lekkiego, ale bardzo trwałego tworzywa, które umożliwia montaż na wysokościach. W zależności od wielkości i stylu Twojego wnętrza, możesz wybierać spośród listew małych i dużych, oraz tych gładkich i ornamentacyjnych. Listwy pokryte są białą farbą podkładową, która stanowi wygładzającą bazę pod kolejne warstwy farby. Wnętrze ozdobione listwami sufitowymi daje efekt pomysłowości i dbałości o detale.**

**de**

Deckenleisten sind Dekorationselemente, welche den Innenraum komplett verändern können. Diese Leisten sind aus einem leichten, aber sehr langlebigem Material hergestellt, welches die Anbringung an der Decke erleichtert. Im Zusammenhang von Größe und Stil Ihres Innenraumes, können Sie aus einer Vielzahl von kleinen und großen, sowie glatten und mit Ornamenten versehenen Leisten wählen. Unsere Leisten sind weiß vorgrundiert, für den perfekten Endanstrich. Innenräume, welche mit Deckenleisten versehen sind, vermitteln den Eindruck von Kreativität und der Liebe zum Detail.

**en**

Cornice mouldings are a decorative feature that can completely change your interior. The mouldings are made of lightweight but very durable material, which makes it possible to install them at heights. Depending on the size and style of your interior, you can choose from small and large mouldings, as well as plain and ornamental ones. The mouldings are covered with a white primer, which is a smoothing base coat for subsequent layers of paint. The interior decorated with cornice mouldings gives the effect of creativity and attention to detail.

**fr**

Les moulures de plafond sont un élément décoratif qui peut complètement changer votre intérieur. Les moulures sont fabriquées dans un matériau léger mais très résistant qui permet une installation en hauteur. Selon la surface et le style de votre intérieur, vous pouvez choisir entre des petites et de grandes moulures, ainsi que des modèles lisses et ornementaux. Les moulures sont recouvertes d'une peinture d'apprêt blanche, qui sert de base de lissage pour les couches de peinture suivantes. Un intérieur décoré de moulures de plafond apporte une touche d'originalité et d'attention aux détails.





MDB164



ProFoam®

200 x 2,1 x 6,2 cm



MDB165

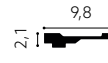

ProFoam®

200 x 2,1 x 9,8 cm



MDB180



ProFoam®

200 x 2,5 x 1,5 cm



MDB135



ProFoam® | Flex (MDB135F)

200 x 2,8 x 3,5 cm



MDB162



ProFoam®

200 x 3,2 x 10,5 cm



MDB163



ProFoam®

200 x 3,2 x 16 cm



MD172



PolyForce® | Flex (MDB172F)

200 x 4 x 4 cm



MDB136



ProFoam®

200 x 4 x 4 cm



MDB112



ProFoam® | Flex (MDB112F) 200 x 4,4 x 4,4 cm



MDB063



ProFoam® 200 x 4,5 x 5,5 cm



MDB174



ProFoam® 200 x 4,9 x 5,2 cm



MDB130

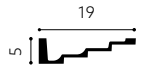

ProFoam® 200 x 5 x 19 cm



MDB147



ProFoam® 200 x 5 x 5,5 cm



MD210



PolyForce® | Flex (MDB210F) 200 x 5 x 5 cm



MD368



PolyForce® 200 x 5,1 x 5,1 cm



MDB167



ProFoam® 200 x 5,5 x 5,5 cm



MDB132



ProFoam®

200 x 5,5 x 8,7 cm

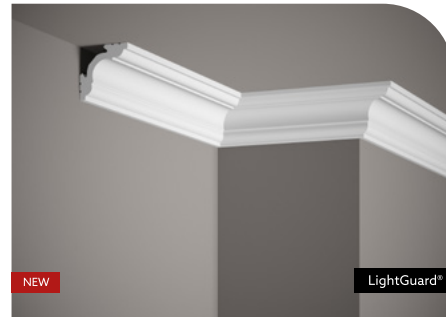

MD106



PolyForce® | Flex (MD106F)

200 x 5,7 x 5,7 cm



MDB127



ProFoam®

200 x 6 x 13 cm



MD145



PolyForce® | Flex (MD145F)

200 x 6 x 6 cm



MDB064



ProFoam®

200 x 6,4 x 6,8 cm



MDB185



ProFoam®

200 x 6,4 x 6,1 cm



MD380



PolyForce®

200 x 6,7 x 6,7 cm

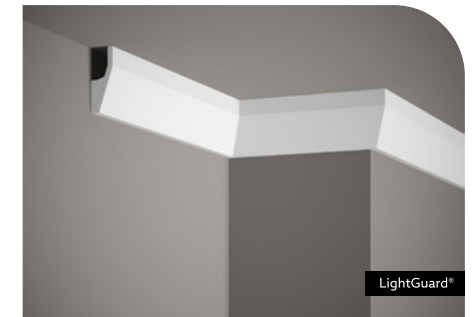

MD118



PolyForce®

200 x 7 x 2,7 cm

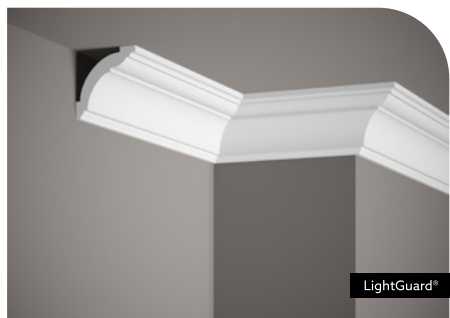

MD367



PolyForce®

200 x 7,2 x 7 cm



MD070



PolyForce®

200 x 7,2 x 4 cm



MDB152



ProFoam®

200 x 7,6 x 7,6 cm



QL019



PolyForce® | ScratchShield®

200 x 8 x 2,5 cm



MD024



PolyForce® | ScratchShield®

200 x 8 x 2,7 cm

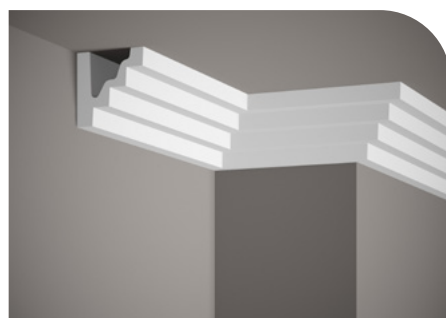

MDB134



ProFoam®

200 x 8 x 8 cm



MDB102



ProFoam®

200 x 8 x 8 cm



MD213



PolyForce® | Flex (MD213F)

200 x 8,1 x 8,1 cm



MD161



PolyForce®

200 x 8,3 x 9,2 cm



MDB117



ProFoam®

200 x 8,3 x 9,2 cm



MD110



PolyForce® | Flex (MDB110F)

200 x 8,9 x 10,6 cm

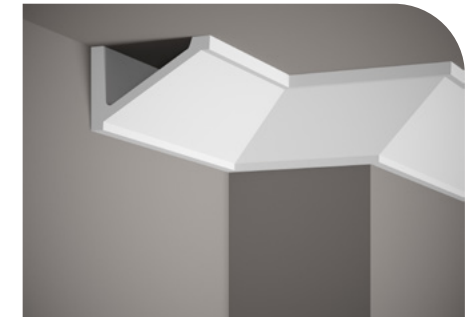

MDB131

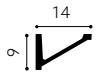

ProFoam®

200 x 9 x 14 cm



MD111



PolyForce®

200 x 9,2 x 6,2 cm



MD137



PolyForce®

200 x 9,6 x 5,5 cm



MDB118



ProFoam® | Flex (MDB118F)

200 x 9,7 x 10 cm



MDB142



ProFoam®

200 x 9,8 x 8 cm

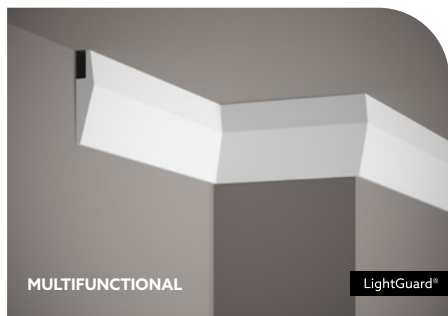

MD016



PolyForce® | ScratchShield®

200 x 10 x 2,3 cm



MDB108



ProFoam® | Flex (MDB108F)

200 x 10 x 10 cm



MDB100



ProFoam®

200 x 10 x 5 cm



MDB158



ProFoam®

200 x 10,5 x 12,5 cm



MD105



PolyForce®

200 x 10,8 x 12 cm



MD025



PolyForce® | ScratchShield®

200 x 11 x 2,7 cm



MD156



PolyForce®

200 x 11 x 14,5 cm



MDB115



ProFoam®

200 x 11 x 6 cm

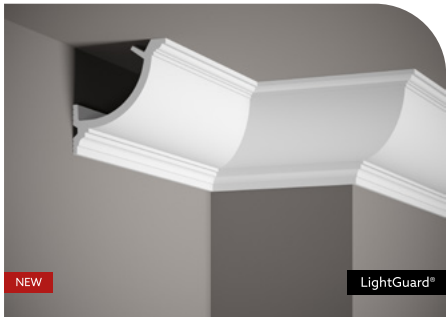

QL027



PolyForce®

200 x 11 x 11 cm



MDB121

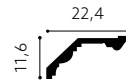

ProFoam®

200 x 11,6 x 22,4 cm



MDB169



ProFoam® | Flex (MDB169F)

200 x 12,4 x 12,6 cm



QS011



PolyForce® | ScratchShield®

200 x 13,5 x 4 cm

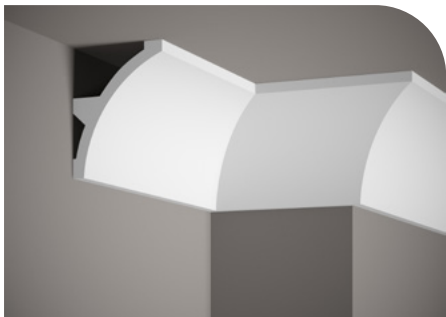

MDB101



ProFoam®

200 x 14 x 10,6 cm



MDB214



ProFoam®

200 x 14,5 x 14,6 cm



MDB154



ProFoam®

200 x 15 x 12,5 cm

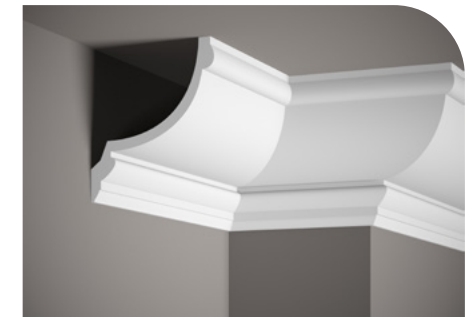

MDB140



ProFoam®

200 x 15 x 16 cm

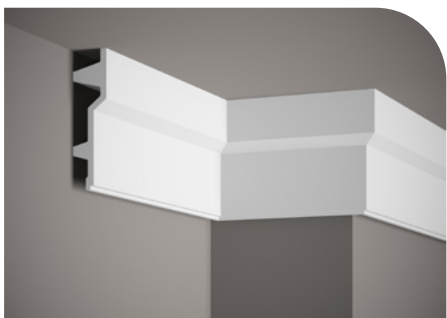

MDB150

ProFoam®

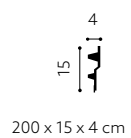

200 x 15 x 4 cm

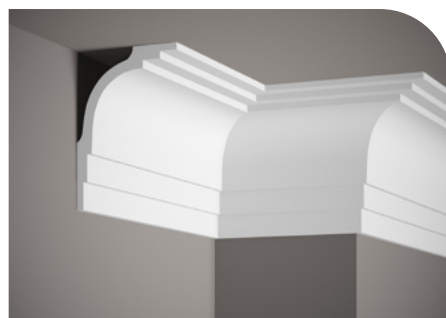

MDB104

ProFoam®

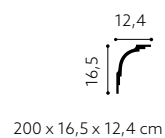

200 x 16,5 x 12,4 cm



MDB128

ProFoam®

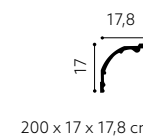

200 x 17 x 17,8 cm

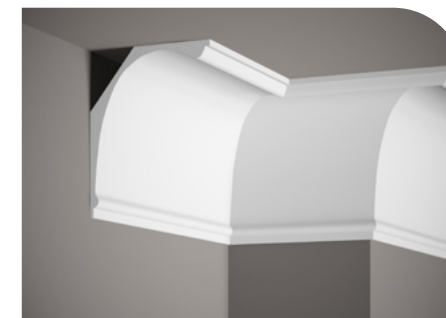

MDB103

ProFoam®

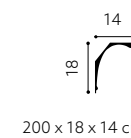

200 x 18 x 14 cm

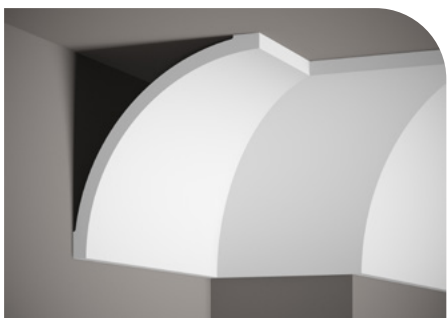

MDB155

ProFoam®

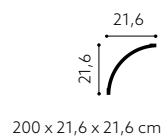

200 x 21,6 x 21,6 cm



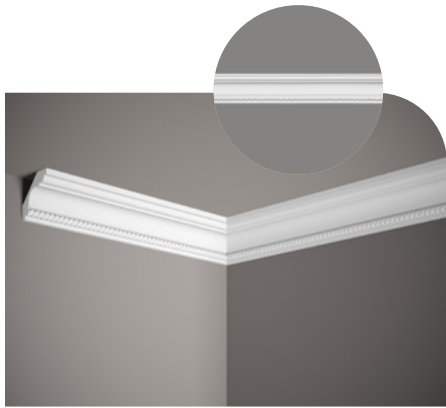

MDA005



ProFoam® | Flex (MDA005F) 200 x 5,8 x 5,8 cm

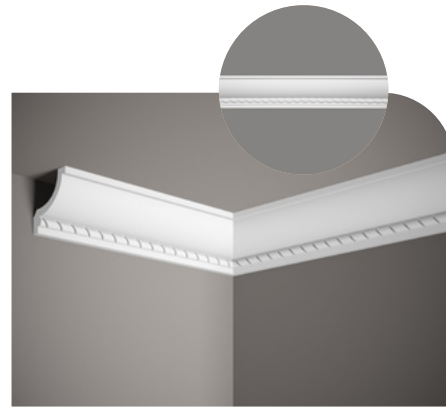

MDA121



ProFoam® 200 x 7 x 7,6 cm

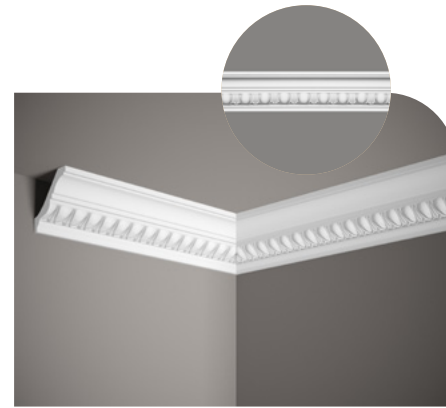

MDA008



ProFoam® 200 x 7,5 x 7,8 cm

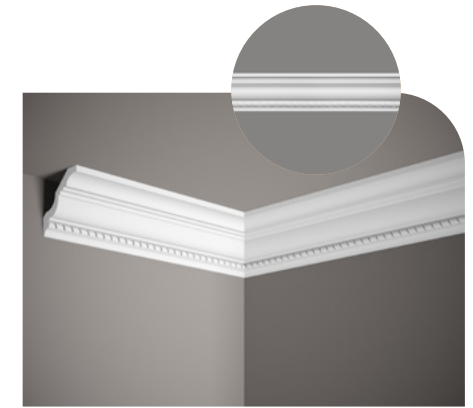

MDA106



ProFoam® 200 x 7,5 x 7,5 cm

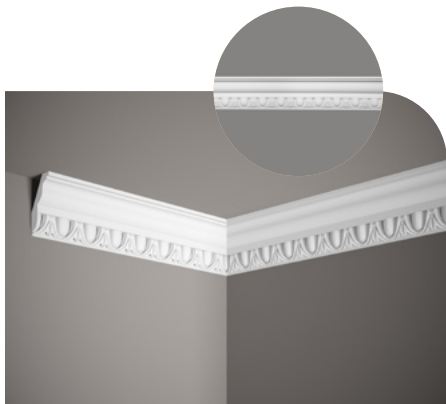

MDA212



ProFoam® | Flex (MDA212F) 200 x 7,8 x 4,4 cm

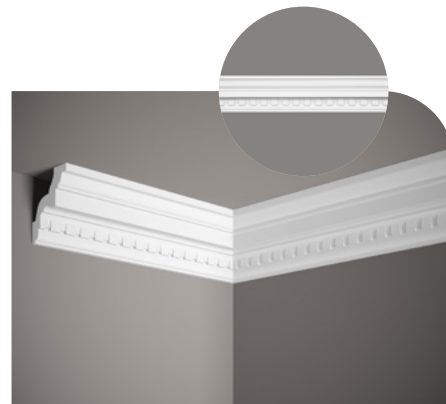

MDA002



ProFoam® 200 x 7,9 x 8,8 cm

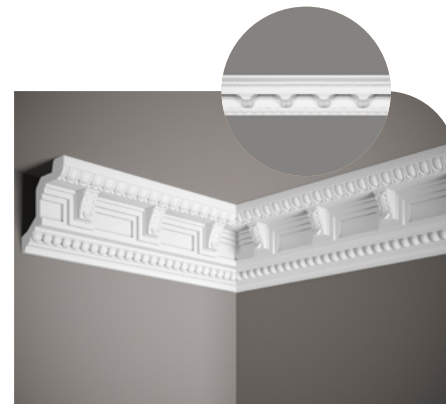

MDA007



ProFoam® 200 x 9,8 x 10 cm

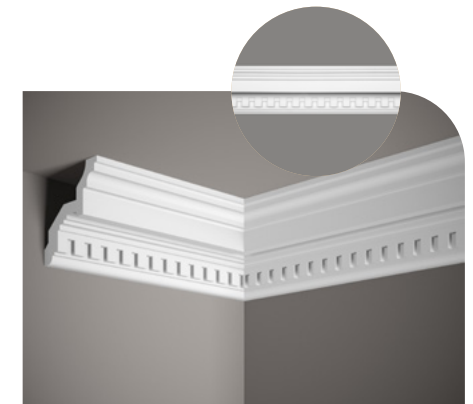

MDA046



ProFoam® | Flex (MDA046F) 200 x 10,7 x 12 cm

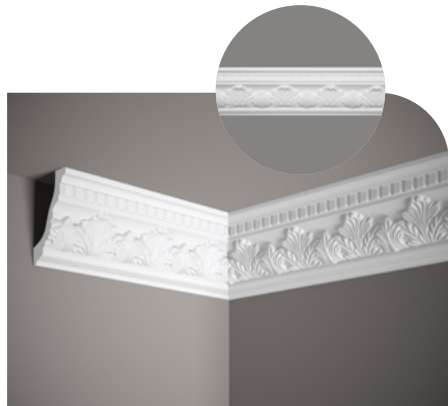

MDA098



ProFoam®

200 x 11,6 x 7,4 cm

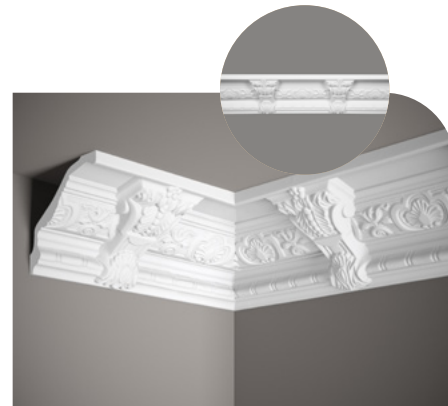

MDA138



ProFoam®

200 x 13 x 16 cm

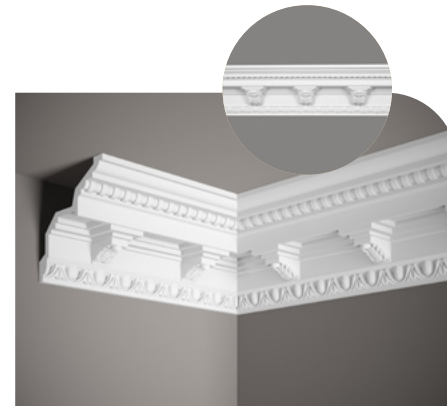

MDA067



ProFoam®

200 x 13,3 x 13,7 cm

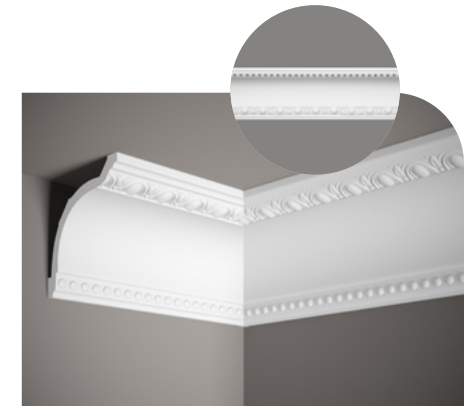

MDA040



ProFoam®

200 x 13,5 x 11 cm

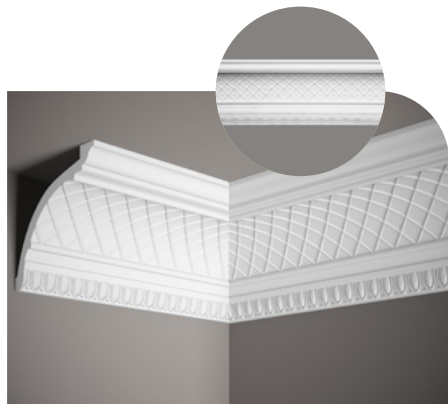

MDA401



ProFoam®

200 x 14,5 x 16,5 cm

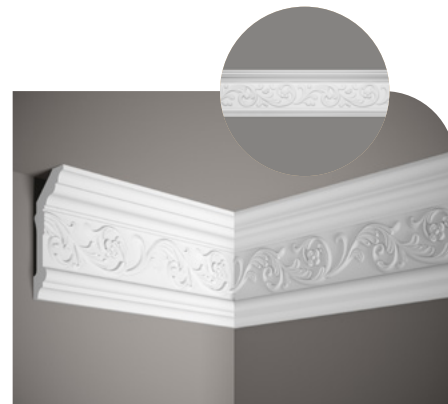

MDA072



ProFoam®

200 x 14,8 x 6,4 cm

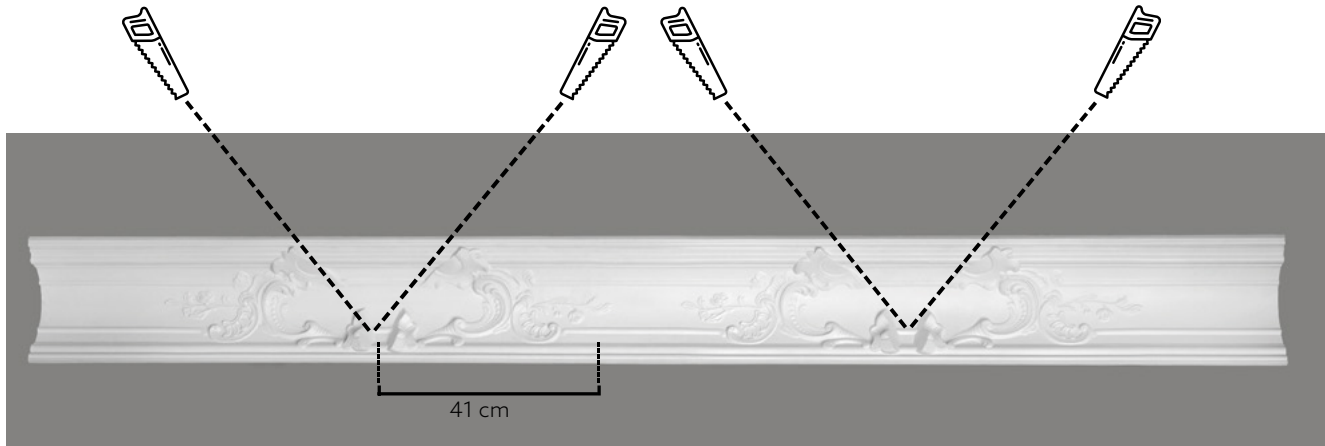

**MDA113**  
200 x 17,8 x 17 cm

Z jednej listwy można wykonać 2 narożniki | You can make 2 corners from one moulding  
| Aus einer Leiste können zwei Ecken gemacht werden | Deux angles peuvent être conçus à partir d'une moulures

ProFoam®

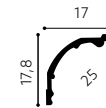

Pasuje do MDB128 i MDA109 | Suitable for the MDB128 and MDA109 | Kompatibel mit MDB128 und MDA109 | Comptable avec les références MDB128 et MDA109

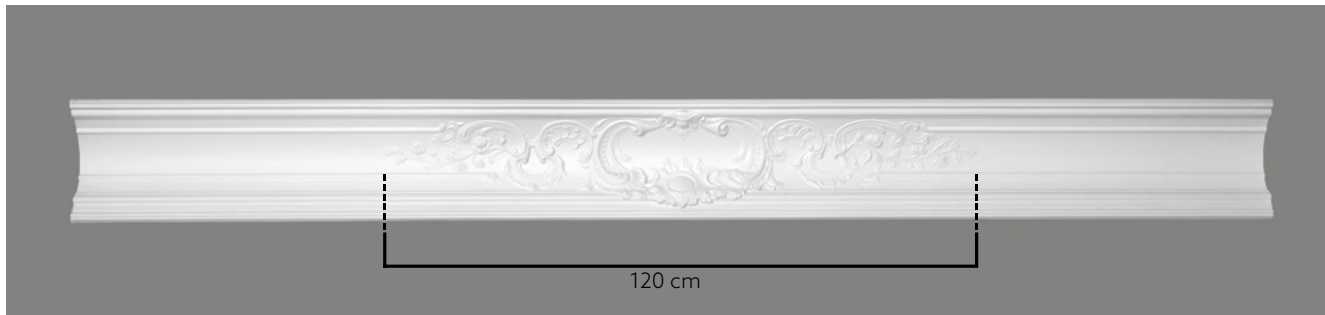

**MDA109**  
200 x 17,8 x 17 cm

ProFoam®

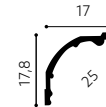

Pasuje do MDB128 i MDA113 | Suitable for the MDB128 and MDA113 | Kompatibel mit MDB128 und MDA113 | Comptable avec les références MDB128 et MDA113

# Listwy oświetleniowe

LIGHTING MOULDINGS | LICHTLEISTEN | CORNICHES D'ÉCLAIRAGE

## pl

Listwy oświetleniowe to najpopularniejszy element nowoczesnych wnętrz. W ciągu dnia spełniają swoją standardową funkcję, dekorując i maskując łączenia między płaszczyznami. Wieczorem są natomiast źródłem subtelnego światła, dodającego pomieszczeniu przytulnego charakteru. Listwy posiadają specjalnie wyprofilowane przestrzenie na ukrycie taśmy LED. Niektóre listwy posiadają innowacyjną technologię LightGuard®, zapobiegającą przebijaniu światła przez powierzchnię listwy. Dzięki temu, oświetlenie jest pięknie rozproszone. Listwy bez technologii LightGuard® wystarczy okleić od wewnętrznej strony taśmą aluminiową, aby uzyskać również nieskazitelny efekt podświetlenia.

## de

LED taugliche Leisten sind die beliebtesten Elemente der modernen Inneneinrichtung. Am Tag erfüllen Sie ihre Standardfunktion, dekorieren und vollenden die Verbindung zwischen Wand und Decke. Am Abend sind sie eine dezente Lichtquelle, welche dem Raum eine gemütliche Charaktereigenschaft verleiht. Die LED-Leisten haben spezielle Innenprofile zur Verdeckung der LED-Stripes. Einige unserer Leisten besitzen zudem auch die neuste LightGuard® Technologie, die das Durchschimmern der Lichtquelle durch die Leiste verhindert. Auf diese Weise wird die Beleuchtung gleichmäßig verteilt. Leisten ohne LightGuard® Technologie können mit einem Aluminiumband von innen beklebt werden, um den Effekt zu erzielen.

## en

Lighting strips are the most popular element of modern interiors. During the day, they perform their standard function by decorating and masking the joints between planes, whereas in the evening they are a source of subtle light that gives the room a cosy feel. The mouldings have specially profiled spaces to hide the LED strip. Some mouldings have an innovative LightGuard® technology, which prevents the light from penetrating the moulding surface. Thanks to this, the light is beautifully dispersed. Mouldings without the LightGuard® technology only need to be taped from the inside with aluminium tape to achieve an equally flawless lighting effect.

## fr

Les corniches d'éclairage sont devenues les éléments de finition les plus populaires des intérieurs modernes. La journée, elles remplissent leur fonction standard, décorer et masquer les angles. Le soir, elles deviennent une source de lumière subtile, ajoutant un caractère cosy à la pièce. Les bandes ont des espaces spécialement profilés pour cacher la bande LED. Certaines bandes disposent de la technologie innovante LightGuard® qui empêche la lumière de pénétrer la surface de la corniche. En conséquence, l'éclairage est magnifiquement diffusé. Les bandes sans technologies LightGuard® doivent simplement être recouvertes de ruban d'aluminium côté l'intérieur pour obtenir un effet d'éclairage tout aussi impeccable.

1. MDB150

2. QR002

3. MD025

4. QL023

5. QL019

6. QL021



QL007 mat  
QL007P satin



PolyForce® | ScratchShield® 200 x 9,3 x 4 cm



QL019 + QL021 mat  
QL019P + QL021P satin



PolyForce® | ScratchShield® 200 x 8 x 2,5 cm  
200 x 2 x 2,5 cm

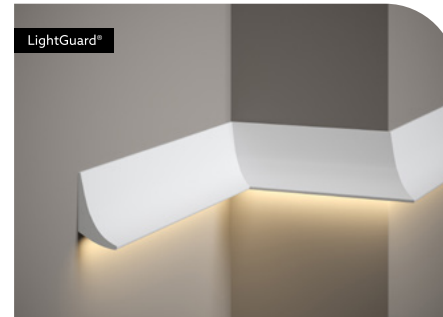

QL006



PolyForce® | ScratchShield® 200 x 7 x 4,2 cm

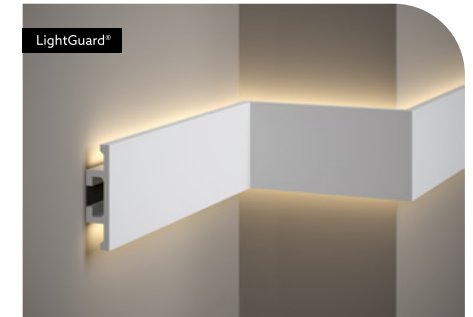

QL017



PolyForce® | ScratchShield® 200 x 10 x 2,5 cm



MD172



PolyForce® | Flex (MDB172F) 200 x 4 x 4 cm



MD210



PolyForce® | Flex (MDB210F) 200 x 5 x 5 cm



MD368



PolyForce® 200 x 5,1 x 5,1 cm



MD106



PolyForce® | Flex (MD106F) 200 x 5,7 x 5,7 cm



MD145



PolyForce® | Flex (MD145F)

200 x 6 x 6 cm



MD380



PolyForce®

200 x 6,7 x 6,7 cm



MD118



PolyForce®

200 x 7 x 2,7 cm



MD070



PolyForce®

200 x 7,2 x 4 cm



MD367



PolyForce®

200 x 7,2 x 7 cm



MD024



PolyForce® | ScratchShield®

200 x 8 x 2,7 cm



QL019



PolyForce® | ScratchShield®

200 x 8 x 2,5 cm



MD213



PolyForce® | Flex (MD213F)

200 x 8,1 x 8,1 cm



MD161



PolyForce®

200 x 8,3 x 9,2 cm



QL002



PolyForce®

200 x 8,5 x 8,5 cm



MD362

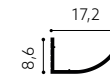

PolyForce®

200 x 8,6 x 17,2 cm



MD110



PolyForce® | Flex (MDB110F)

200 x 8,9 x 10,6 cm



MD111



PolyForce®

200 x 9,2 x 6,2 cm



MD137



PolyForce®

200 x 9,6 x 5,5 cm



MDB100



ProFoam®

200 x 10 x 5 cm



MD016



PolyForce®

200 x 10 x 2,3 cm



MD105

PolyForce®

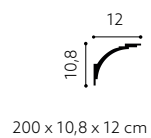

200 x 10,8 x 12 cm



MD025

PolyForce®



200 x 11 x 2,7 cm



QL027

PolyForce®



200 x 11 x 11 cm



MD156

PolyForce®



200 x 11 x 14,5 cm



MDB115

ProFoam®



200 x 11 x 6 cm

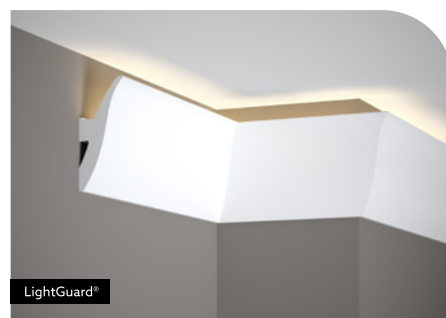

QL009

PolyForce®



200 x 12 x 4,7 cm

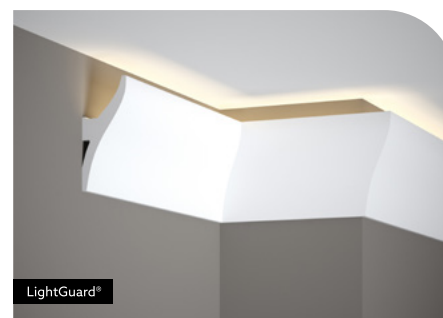

QL010

PolyForce®



200 x 12 x 4,2 cm



QL011

PolyForce®



200 x 12,3 x 9,5 cm





QS011



PolyForce® | ScratchShield® 200 x 13,5 x 4 cm

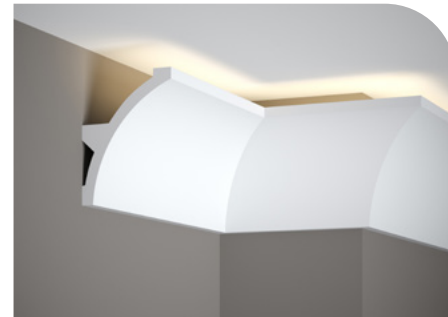

MDB101



ProFoam® 200 x 14 x 10,6 cm

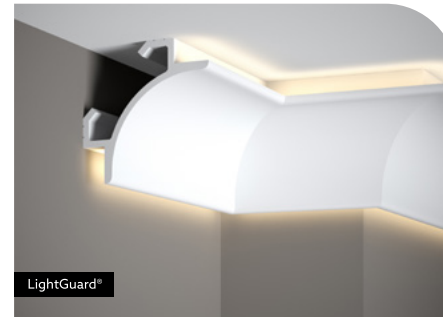

QL001



PolyForce® 200 x 14,7 x 14,7 cm

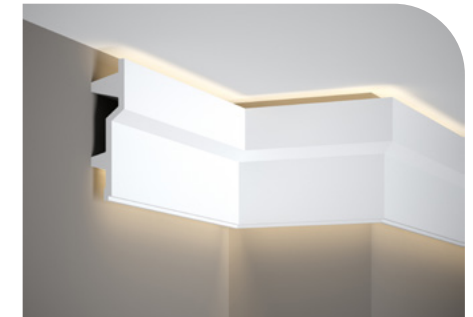

MDB150



ProFoam® 200 x 15 x 4 cm



# LAMELLI

MARDOM  
DECOR

pl

**Lamelli by Mardom Decor to synonim jakości, precyzji i najlepszego designu. Lamele ścienne to absolutny hit wnętrzarski, który na stałe zagościł we współczesnym projektowaniu. Doświadczenie oraz jakość, którą wypracowaliśmy w produkcji sztukaterii, zainspirowały nas do stworzenia tego wyjątkowego produktu, który całkowicie odmieni każde wnętrze.**

de

Lamelli von Mardom Decor ist ein Synonym für Qualität, Präzision und Top-Design. Wandpaneele sind seit einiger Zeit ein absoluter Hit in der Innenarchitektur und haben sich zu einem festen Bestandteil des zeitgenössischen Designs entwickelt. Profitieren Sie von unserer Erfahrung und schaffen Sie sich ein wohliges Zuhause, dass sich durch unser breites Interieur völlig verändern wird.

en

Lamelli by Mardom Decor is a byword for quality, precision, and the best design. Wall panels are an absolute hit in interior design and a permanent fixture in contemporary design. The experience and high level of quality we have achieved in the production of mouldings have inspired us to create this unique product that completely changes any interior.

fr

Lamelli by Mardom Decor est synonyme de qualité, de précision et du meilleur design. Les lamelles murales sont LA tendance déco qui s'est installée pour de bon dans le design moderne. Notre expérience et la qualité de fabrication atteinte nous ont encouragés à créer ce produit exceptionnel qui peut complètement changer chaque intérieur.

1. MD359B

2. L0105

3. MD002

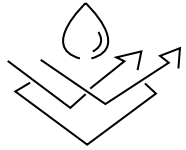

## WODOODPORNE

WATER RESISTANT

WASSERFEST

IMPERMÉABLE

Pełna odporność na wilgoć,  
umożliwiająca montaż w mokrych  
pomieszczeniach

Fully humidity resistant,  
can be installed in wet rooms

Volle Feuchtigkeitsbeständigkeit,  
die eine Installation in Nassräumen  
ermöglicht

Résistance totale à l'humidité,  
permettant le montage dans les pièces  
humides

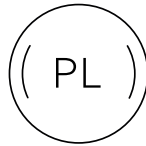

## POLSKA PRODUKCJA

MADE IN POLAND

HERGESTELLT IN POLEN

FABRIQUÉ EN POLOGNE

Produkt zaprojektowany  
i w całości  
wyprodukowany w Polsce

Product designed and fully  
manufactured in Poland

Produkt designet, und  
hergestellt in Polen

Le produit est entièrement  
conçu et fabriqué en  
Pologne



## MAKSYMALNE UTWARDZENIE

MAXIMUM HARDENING

MAXIMALE HÄRTUNG

AKUSTIKVERBESSERUNG

Produkt z technologią ScratchShield  
polegającą na maksymalnym utwardzeniu  
powierzchni

Product based on ScratchShield  
technology for maximum surface  
hardening

Produkt mit ScratchShieldTechnologie für  
maximale Oberflächenhärtung

Le produit se caractérise par la  
technologie ScratchShield qui consiste en  
le durcissement maximal de la surface

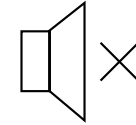

## POPRAWA AKUSTYKI

ACOUSTICS IMPROVEMENT

DURCISSEMENT MAXIMAL

AMÉLIORATION DE L'ACOUSTIQUE

Efekt redukcji dźwięków we  
wnętrzu i pozbycie się echa

Interior sound reduction  
effect in the interior and  
echo cancellation

Geräuschreduzierung und  
Echounterdrückung im  
Innenraum

Effet de réduction des sons  
à l'intérieur et élimination  
de l'écho



### ŁATWY MONTAŻ

EASY TO INSTALL

EINFACHE MONTAGE

MONTAGE FACILE

Łatwy, szybki i czysty montaż przy użyciu kleju Mardom Decor

Easy, quick and clean installation using Mardom Decor adhesive

Einfache, schnelle und saubere Montage mit Mardom Decor Kleber

Un montage facile, rapide et propre grâce à la colle Mardom Decor



### PRZYJAZNE ŚRODOWISKU

ECO FRIENDLY

UMWELTFREUNDLICH

RESPECTUEUX DE L'ENVIRONNEMENT

Produkty podlegają recyklingowi. Produkcja odbywa się w obiegu zamkniętym

The products are recyclable. Production is based on a closed-loop cycle

Die Produkte sind recycelbar. Die Produktion findet in einem geschlossenen Kreislauf statt

Les produits sont recyclables. La production se fait dans un circuit fermé



### DŁUGOŚĆ LAMELI BEZ DOCINANIA

NO NEED TO CUT TO ADJUST THE LENGTH

PANEELLÄNGE OHNE SCHNEIDEN

LONGUEUR DES LAMELLES SANS DÉCOUPE

Optymalna długość 270 cm umożliwia montaż od podłogi do sufitu bez tworzenia łączeń

Optimum length of 270 cm enables floor-to-ceiling installation without joints

Die optimale Länge von 270 cm ermöglicht eine fugenlose Verlegung vom Boden bis zur Decke

La longueur optimale de 270 cm assure un montage du sol au plafond sans jonctions



### NATURALNE KOLORY

NATURAL COLOURS

NATÜRLICHE FARBEN

COULEURS NATURELLES

Piękne, naturalne odcienie drewna, pasujące do różnych stylów wnętrzarskich

Beautiful, natural wood tones to suit different interior styles

Schöne, natürliche Holzttöne, die zu verschiedenen Einrichtungsstilen passen

De magnifiques nuances de bois qui vont avec différents styles de déco

\* Lamelle występują też w długości 200 cm.

\* The lamellas are also available in lengths of 200 cm.

\* Die Lamellen sind auch in 200 cm Länge erhältlich.

\* Les lamelles existent aussi en longueur de 200 cm.

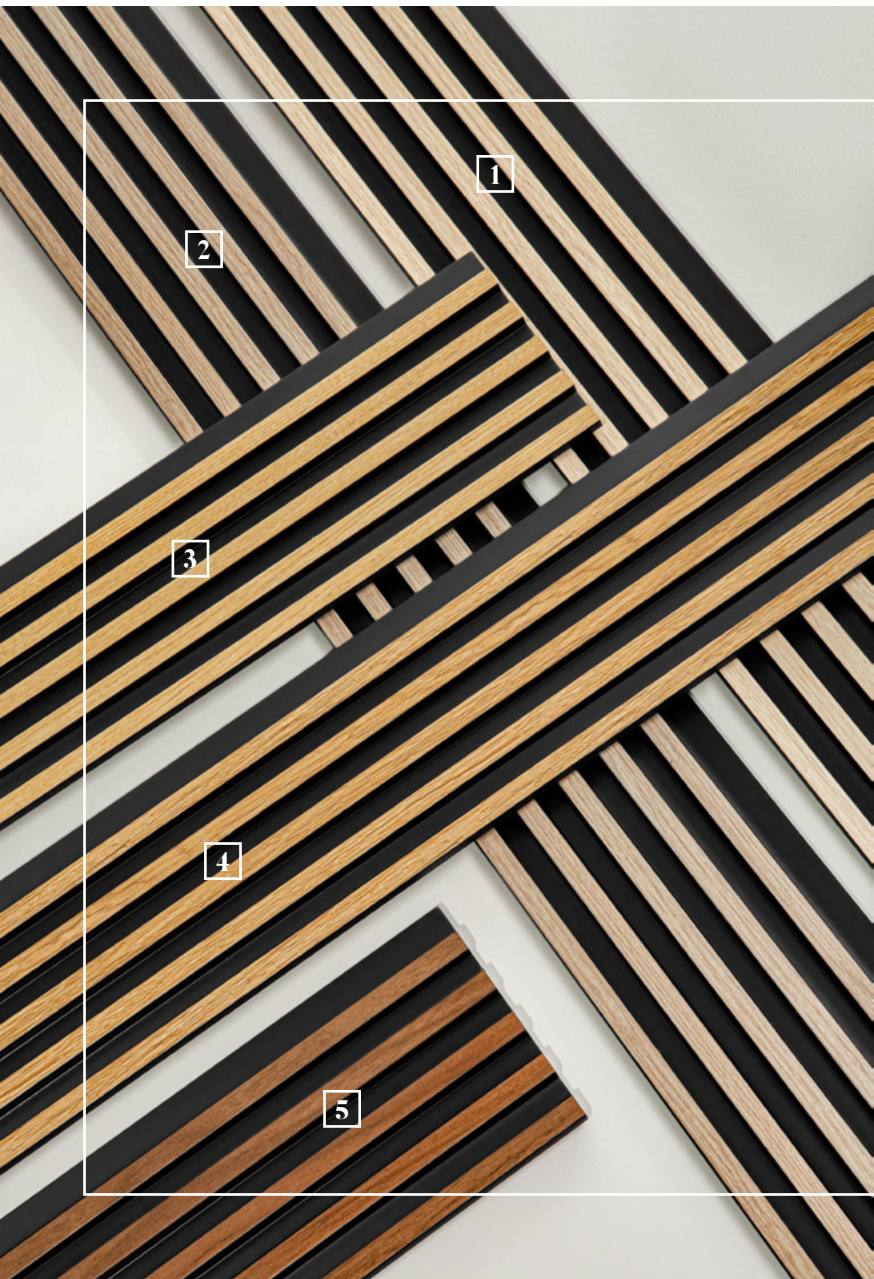

- 1. L0102
- 2. L0103
- 3. L0105
- 4. L0106
- 5. L0104

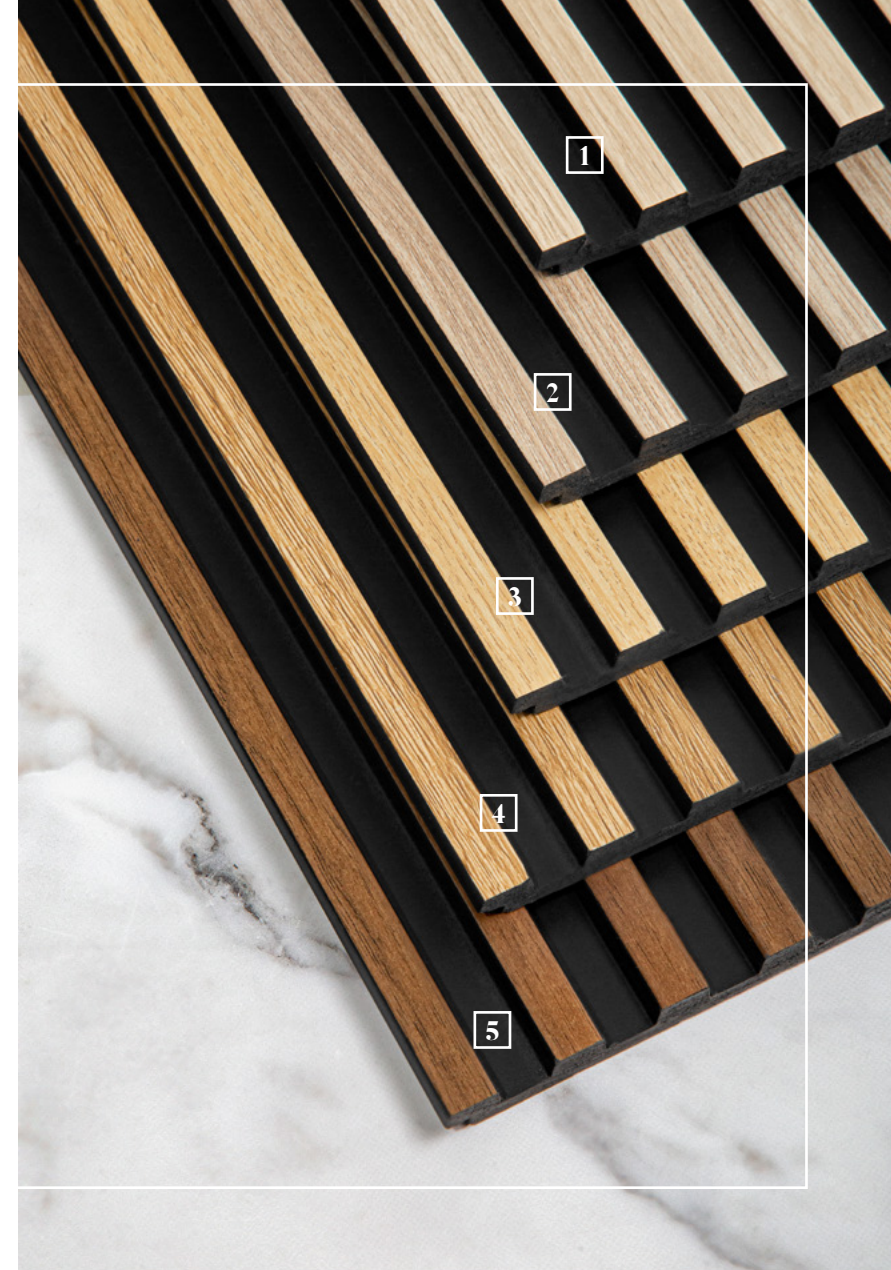

# STRETTO

## KOLORY

COLOURS  
FARBEN  
COULEURS

---



### BIAŁY

WHITE | WEISS | BLANCHE

**L0101** - 270 cm  
**L0101T** - 200 cm



### DĄB JASNY

LIGHT OAK | EICHE HELL | CHÊNE CLAIR

**L0102** - 270 cm  
**L0102T** - 200 cm



### DĄB SZARY

GREY OAK | EICHE GRAU | CHÊNE GRIS

**L0103** - 270 cm  
**L0103T** - 200 cm



### DĄB CIEMNY

DARK OAK | EICHE DUNKEL  
| CHÊNE SOMBRE

**L0104** - 270 cm  
**L0104T** - 200 cm



### DĄB NATURALNY

NATURAL OAK | EICHE NATUR  
| CHÊNE NATUREL

**L0105** - 270 cm  
**L0105T** - 200 cm



### DĄB KLASYCZNY

CLASSIC OAK | EICHE KLASSIK  
| CHÊNE CLASSIQUE

**L0106** - 270 cm  
**L0106T** - 200 cm

## WYMIAR TECHNICZNY

TECHNICAL DIMENSION | TECHNISCHE DATEN | DIMENSIONS TECHNIQUES

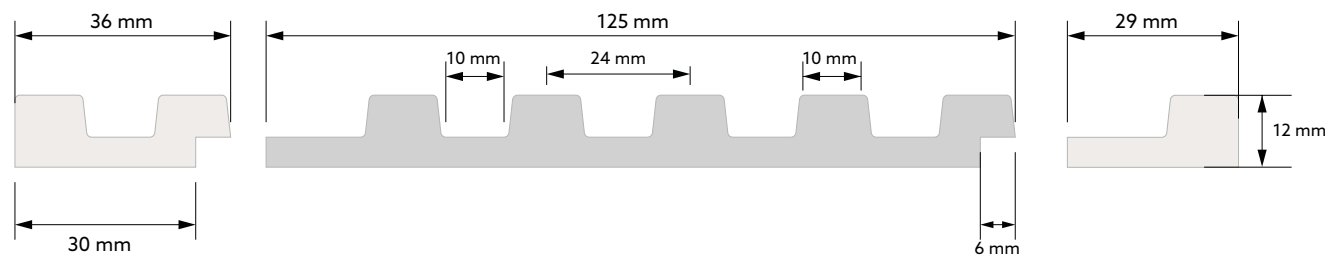

## ZAKOŃCZENIE LEWE

LEFT END PROFILE  
ANSCHLUSS LINKS  
EXTRÉMITÉ GAUCHE

## LAMELA

WALL PANEL  
WANDPANEEL  
LAMELLE

## ZAKOŃCZENIE PRAWO

RIGHT END PROFILE  
ANSCHLUSS RECHTS  
EXTRÉMITÉ DROITE

## WYMIAR PO MONTAŻU

DIMENSION AFTER ASSEMBLY | ABMESSUNG NACH DER MONTAGE | DIMENSIONS APRÈS MONTAGE

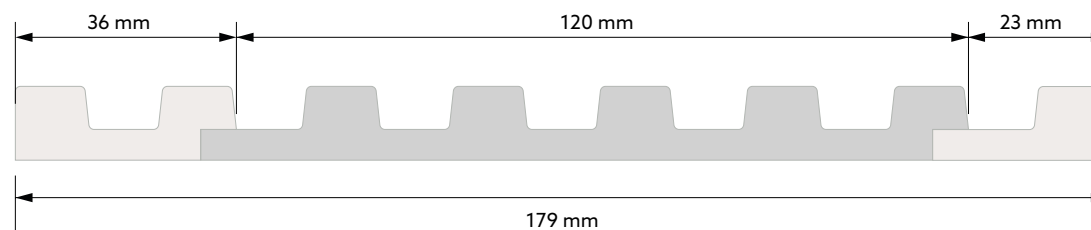

## ZAKOŃCZENIE LEWE

LEFT END PROFILE  
ANSCHLUSS LINKS  
EXTRÉMITÉ GAUCHE

## LAMELA

WALL PANEL  
WANDPANEEL  
LAMELLE

## ZAKOŃCZENIE PRAWO

RIGHT END PROFILE  
ANSCHLUSS RECHTS  
EXTRÉMITÉ DROITE

KOLEKCJA / COLLECTION / KOLLEKTION / COLLECTION: **STRETTO**

KOLOR / COLOUR / FARBE / COULEUR: **BIAŁY / WHITE / WEISS / BLANCHE**

LAMELA / WALL PANEL / WANDPANEEL / LAMELLE: **L0101**

ZAKOŃCZENIE LEWE / LEFT END PROFILE / ANSCHLUSS LINKS / EXTRÉMITÉ GAUCHE: **L0101L**

ZAKOŃCZENIE PRAWO / RIGHT END PROFILE / ANSCHLUSS RECHTS / EXTRÉMITÉ DROITE: **L0101R**

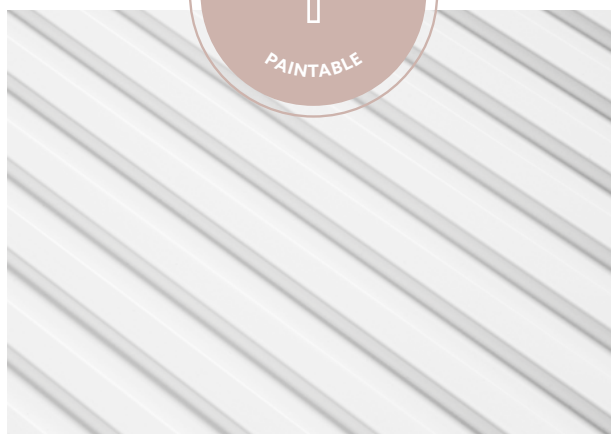
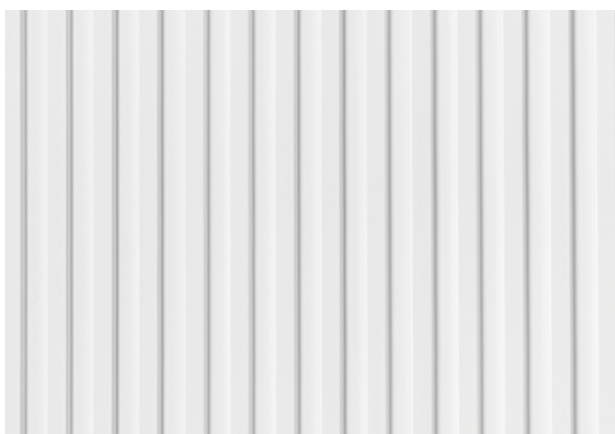
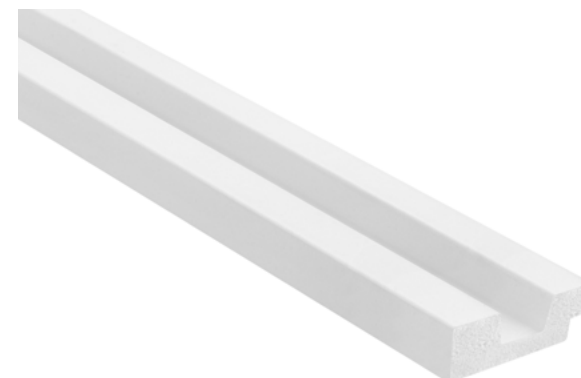



KOLEKCJA / COLLECTION / KOLLEKTION / COLLECTION: **STRETTO**

KOLOR / COLOUR / FARBE / COULEUR: **DĄB JASNY / LIGHT OAK / EICHE HELL / CHÊNE CLAIR**

LAMELA / WALL PANEL / WANDPANEEL / LAMELLE: **L0102**

ZAKOŃCZENIE LEWE / LEFT END PROFILE / ANSCHLUSS LINKS / EXTRÉMITÉ GAUCHE: **L0102L**

ZAKOŃCZENIE PRAWE / RIGHT END PROFILE / ANSCHLUSS RECHTS / EXTRÉMITÉ DROITE: **L0102R**

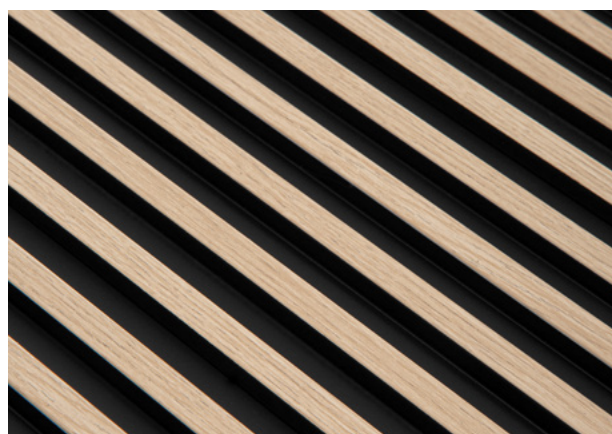
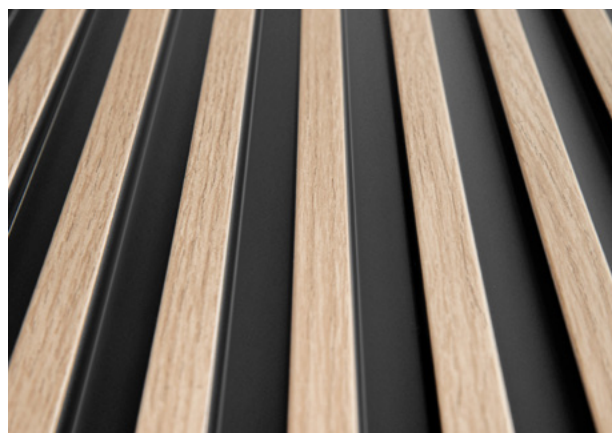

KOLEKCJA / COLLECTION / KOLLEKTION / COLLECTION: **STRETTO**

KOLOR / COLOUR / FARBE / COULEUR: **DĄB SZARY / GREY OAK / EICHE GRAU / CHÊNE GRIS**

LAMELA / WALL PANEL / WANDPANEEL / LAMELLE: **L0103**

ZAKOŃCZENIE LEWE / LEFT END PROFILE / ANSCHLUSS LINKS / EXTRÉMITÉ GAUCHE: **L0103L**

ZAKOŃCZENIE PRAWE / RIGHT END PROFILE / ANSCHLUSS RECHTS / EXTRÉMITÉ DROITE: **L0103R**

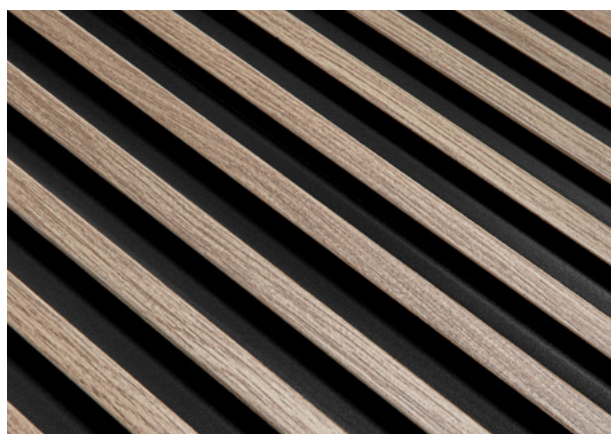

KOLEKCJA / COLLECTION / KOLLEKTION / COLLECTION: **STRETTO**  
KOLOR / COLOUR / FARBE / COULEUR: **DĄB CIEMNY / DARK OAK / EICHE DUNKEL / CHÊNE SOMBRE**  
LAMELA / WALL PANEL / WANDPANEEL / LAMELLE: **L0104**  
ZAKOŃCZENIE LEWE / LEFT END PROFILE / ANSCHLUSS LINKS / EXTRÉMITÉ GAUCHE: **L0104L**  
ZAKOŃCZENIE PRAWO / RIGHT END PROFILE / ANSCHLUSS RECHTS / EXTRÉMITÉ DROITE: **L0104R**

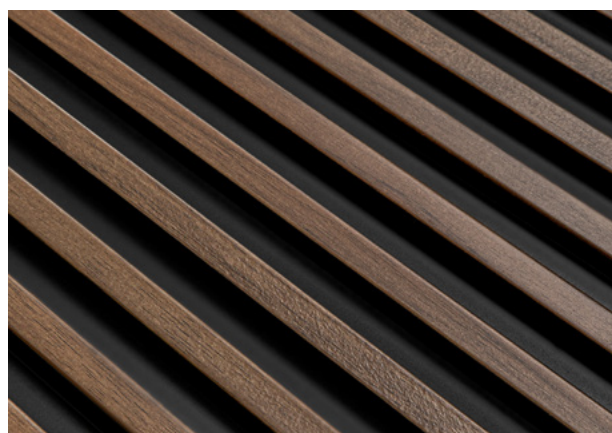
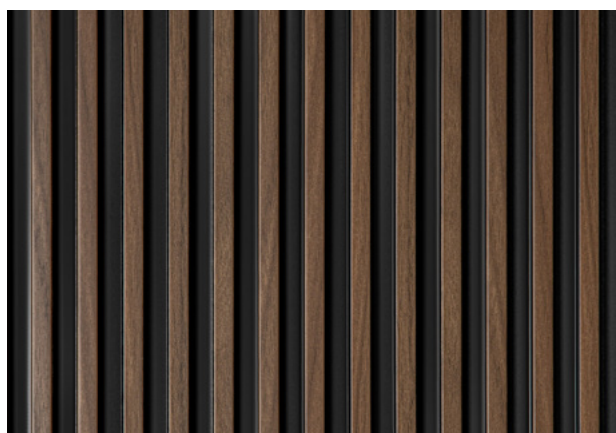
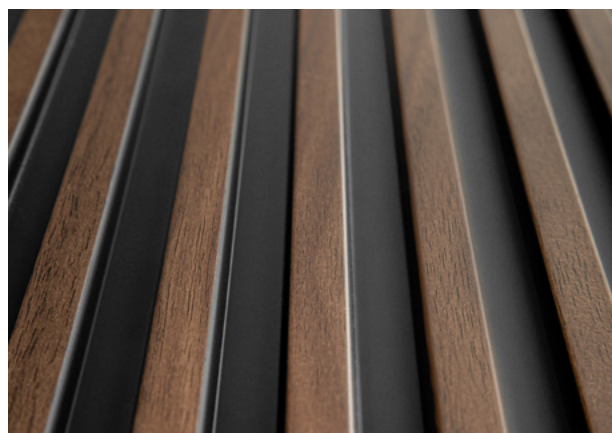

KOLEKCJA / COLLECTION / KOLLEKTION / COLLECTION: **STRETTO**

KOLOR / COLOUR / FARBE / COULEUR: **DĄB NATURALNY / NATURAL OAK / EICHE NATUR / CHÊNE NATUREL**

LAMELA / WALL PANEL / WANDPANEEL / LAMELLE: **L0105**

ZAKOŃCZENIE LEWE / LEFT END PROFILE / ANSCHLUSS LINKS / EXTRÉMITÉ GAUCHE: **L0105L**

ZAKOŃCZENIE PRAWO / RIGHT END PROFILE / ANSCHLUSS RECHTS / EXTRÉMITÉ DROITE: **L0105R**

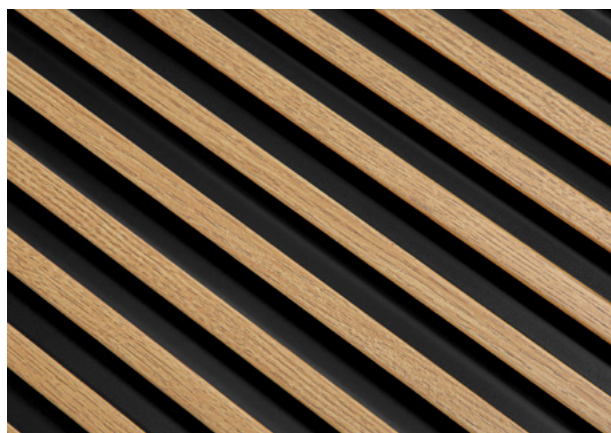

KOLEKCJA / COLLECTION / KOLLEKTION / COLLECTION: **STRETTO**

KOLOR / COLOUR / FARBE / COULEUR: **DĄB KLASYCZNY / CLASSIC OAK / EICHE KLASSIK / CHÊNE CLASSIQUE**

LAMELA / WALL PANEL / WANDPANEEL / LAMELLE: **L0106**

ZAKOŃCZENIE LEWE / LEFT END PROFILE / ANSCHLUSS LINKS / EXTRÉMITÉ GAUCHE: **L0106L**

ZAKOŃCZENIE PRAWE / RIGHT END PROFILE / ANSCHLUSS RECHTS / EXTRÉMITÉ DROITE: **L0106R**

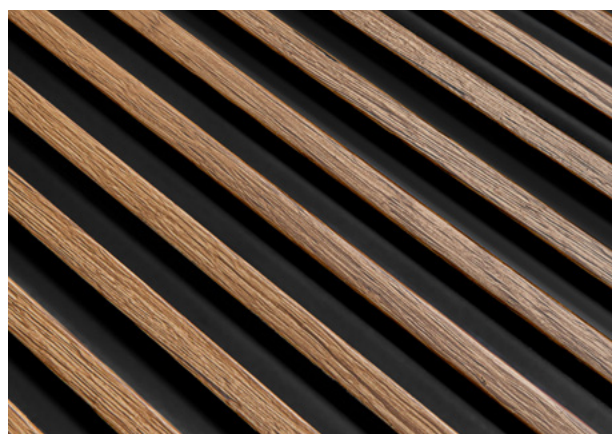
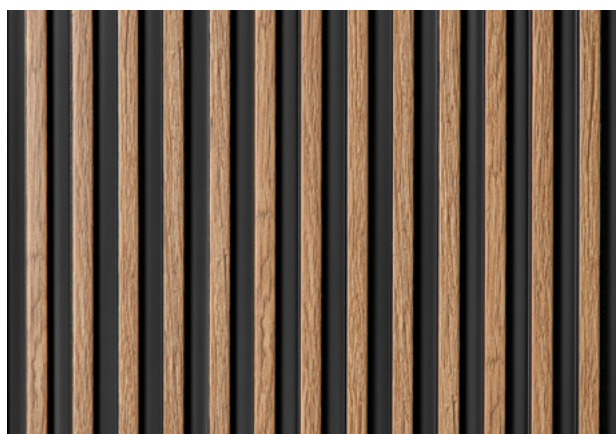

# MEDIO

## KOLORY

COLOURS  
FARBEN  
COULEURS

---



### BIAŁY

WHITE | WEISS | BLANCHE

**L0201** - 270 cm  
**L0201T** - 200 cm



### DĄB JASNY

LIGHT OAK | EICHE HELL | CHÊNE CLAIR

**L0202** - 270 cm  
**L0202T** - 200 cm



### DĄB SZARY

GREY OAK | EICHE GRAU | CHÊNE GRIS

**L0203** - 270 cm  
**L0203T** - 200 cm



### DĄB CIEMNY

DARK OAK | EICHE DUNKEL  
| CHÊNE SOMBRE

**L0204** - 270 cm  
**L0204T** - 200 cm



### DĄB NATURALNY

NATURAL OAK | EICHE NATUR  
| CHÊNE NATUREL

**L0205** - 270 cm  
**L0205T** - 200 cm



### DĄB KLASYCZNY

CLASSIC OAK | EICHE KLASSIK  
| CHÊNE CLASSIQUE

**L0206** - 270 cm  
**L0206T** - 200 cm

## WYMIAR TECHNICZNY

TECHNICAL DIMENSION | TECHNISCHE DATEN | DIMENSIONS TECHNIQUES

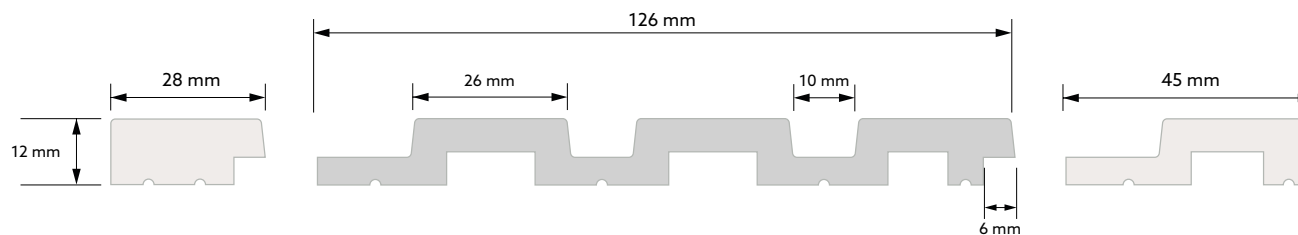

## ZAKOŃCZENIE LEWE

LEFT END PROFILE  
ANSCHLUSS LINKS  
EXTRÉMITÉ GAUCHE

## LAMELA

WALL PANEL  
WANDPANEEL  
LAMELLE

## ZAKOŃCZENIE PRAWO

RIGHT END PROFILE  
ANSCHLUSS RECHTS  
EXTRÉMITÉ DROITE

## WYMIAR PO MONTAŻU

DIMENSION AFTER ASSEMBLY | ABMESSUNG NACH DER MONTAGE | DIMENSIONS APRÈS MONTAGE

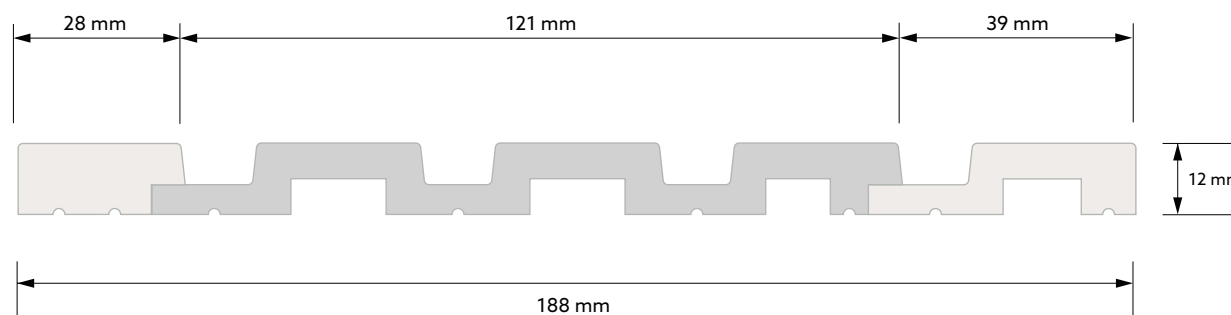

## ZAKOŃCZENIE LEWE

LEFT END PROFILE  
ANSCHLUSS LINKS  
EXTRÉMITÉ GAUCHE

## LAMELA

WALL PANEL  
WANDPANEEL  
LAMELLE

## ZAKOŃCZENIE PRAWO

RIGHT END PROFILE  
ANSCHLUSS RECHTS  
EXTRÉMITÉ DROITE

KOLEKCJA / COLLECTION / KOLLEKTION / COLLECTION: **MEDIO**

KOLOR / COLOUR / FARBE / COULEUR: **BIAŁY / WHITE / WEISS / BLANCHE**

LAMELA / WALL PANEL / WANDPANEEL / LAMELLE: **L0201**

ZAKOŃCZENIE LEWE / LEFT END PROFILE / ANSCHLUSS LINKS / EXTRÉMITÉ GAUCHE: **L0201L**

ZAKOŃCZENIE PRAWO / RIGHT END PROFILE / ANSCHLUSS RECHTS / EXTRÉMITÉ DROITE: **L0201R**

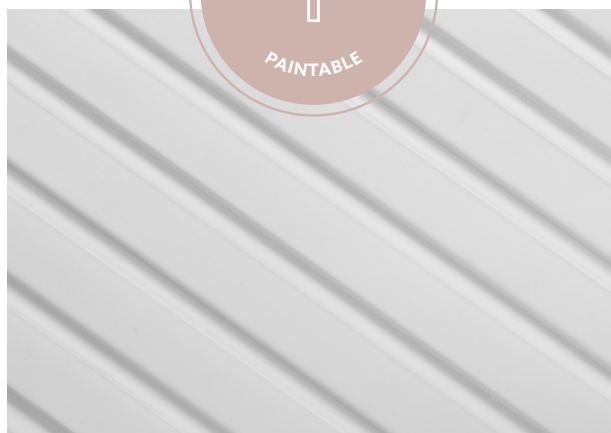
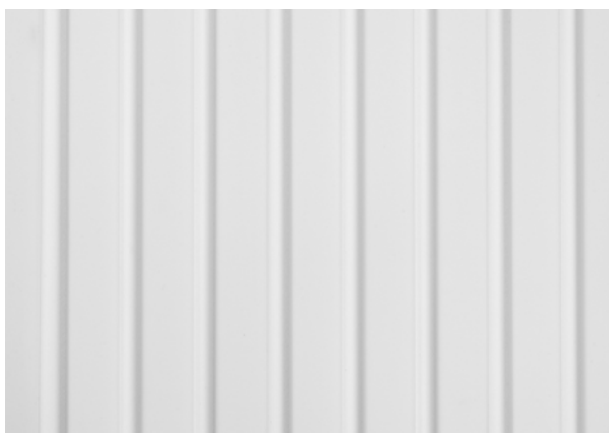



KOLEKCJA / COLLECTION / KOLLEKTION / COLLECTION: **MEDIO**  
KOLOR / COLOUR / FARBE / COULEUR: **DĄB JASNY / LIGHT OAK / EICHE HELL / CHÊNE CLAIR**  
LAMELA / WALL PANEL / WANDPANEEL / LAMELLE: **L0202**  
ZAKOŃCZENIE LEWE / LEFT END PROFILE / ANSCHLUSS LINKS / EXTRÉMITÉ GAUCHE: **L0202L**  
ZAKOŃCZENIE PRAWO / RIGHT END PROFILE / ANSCHLUSS RECHTS / EXTRÉMITÉ DROITE: **L0202R**

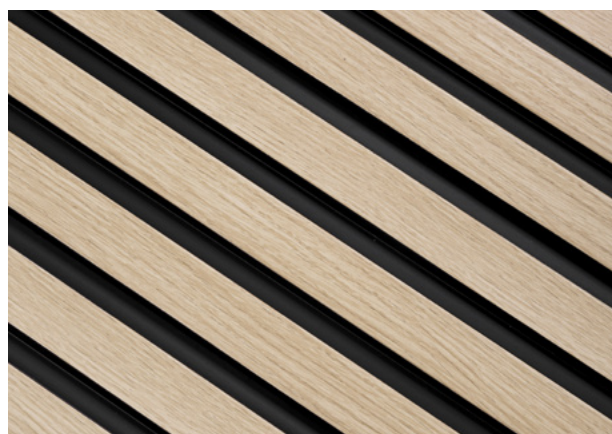
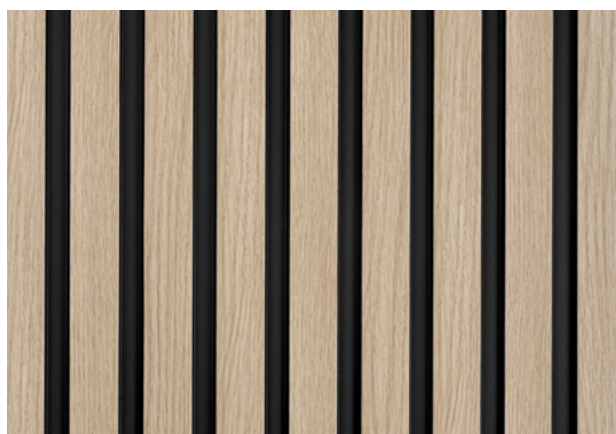

KOLEKCJA / COLLECTION / KOLLEKTION / COLLECTION: **MEDIO**

KOLOR / COLOUR / FARBE / COULEUR: **DĄB SZARY / GREY OAK / EICHE GRAU / CHÊNE GRIS**

LAMELA / WALL PANEL / WANDPANEEL / LAMELLE: **L0203**

ZAKOŃCZENIE LEWE / LEFT END PROFILE / ANSCHLUSS LINKS / EXTRÉMITÉ GAUCHE: **L0203L**

ZAKOŃCZENIE PRAWO / RIGHT END PROFILE / ANSCHLUSS RECHTS / EXTRÉMITÉ DROITE: **L0203R**

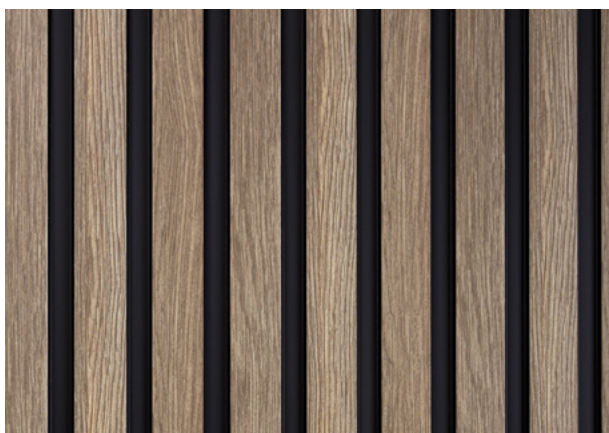

KOLEKCJA / COLLECTION / KOLLEKTION / COLLECTION: **MEDIO**  
KOLOR / COLOUR / FARBE / COULEUR: **DĄB CIEMNY / DARK OAK / EICHE DUNKEL / CHÊNE SOMBRE**  
LAMELA / WALL PANEL / WANDPANEEL / LAMELLE: **L0204**  
ZAKOŃCZENIE LEWE / LEFT END PROFILE / ANSCHLUSS LINKS / EXTRÉMITÉ GAUCHE: **L0204L**  
ZAKOŃCZENIE PRAWE / RIGHT END PROFILE / ANSCHLUSS RECHTS / EXTRÉMITÉ DROITE: **L0204R**

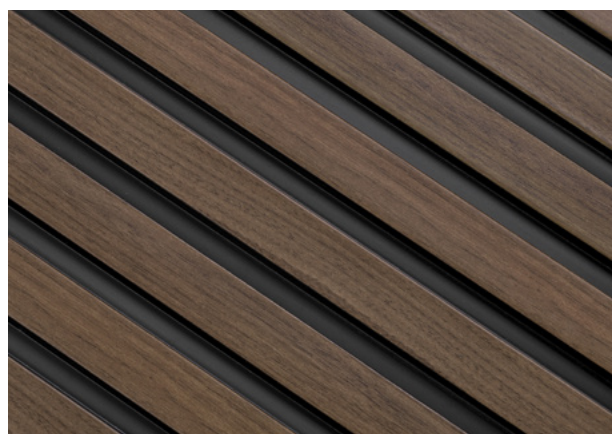
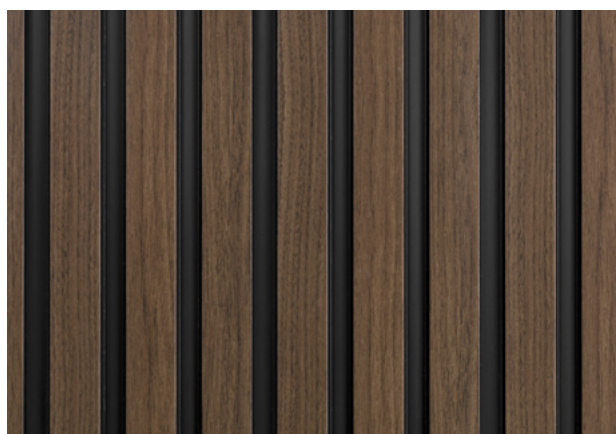
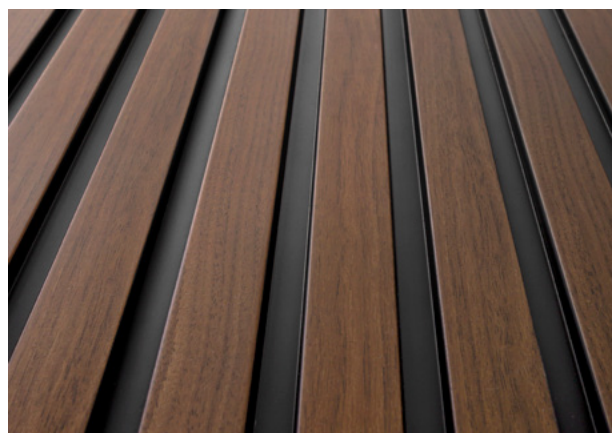

KOLEKCJA / COLLECTION / KOLLEKTION / COLLECTION: **MEDIO**

KOLOR / COLOUR / FARBE / COULEUR: **DĄB NATURALNY / NATURAL OAK / EICHE NATUR / CHÊNE NATUREL**

LAMELA / WALL PANEL / WANDPANEEL / LAMELLE: **L0205**

ZAKOŃCZENIE LEWE / LEFT END PROFILE / ANSCHLUSS LINKS / EXTRÉMITÉ GAUCHE: **L0205L**

ZAKOŃCZENIE PRAWO / RIGHT END PROFILE / ANSCHLUSS RECHTS / EXTRÉMITÉ DROITE: **L0205R**

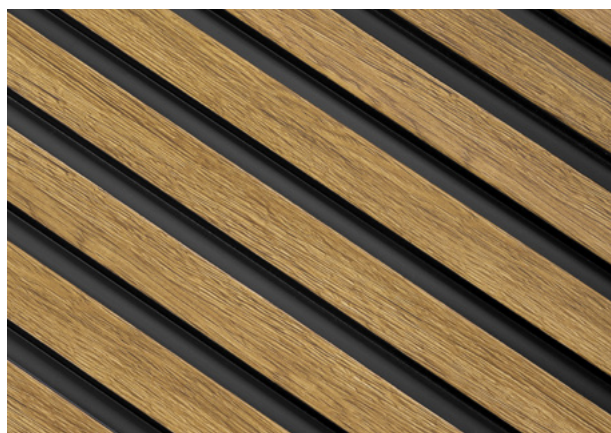
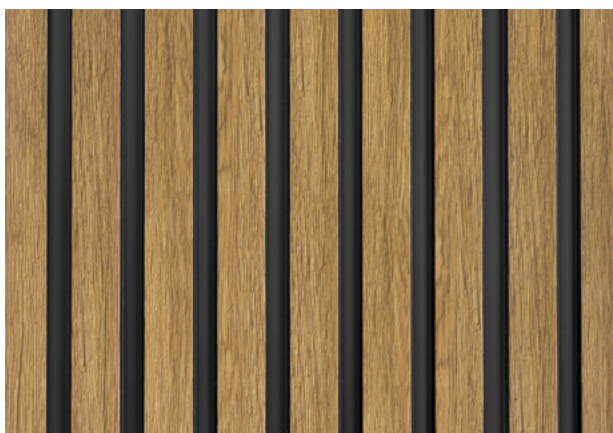

KOLEKCJA / COLLECTION / KOLLEKTION / COLLECTION: **MEDIO**  
KOLOR / COLOUR / FARBE / COULEUR: **DĄB KLASYCZNY / CLASSIC OAK / EICHE KLASSIK / CHÊNE CLASSIQUE**  
LAMELA / WALL PANEL / WANDPANEEL / LAMELLE: **L0206**  
ZAKOŃCZENIE LEWE / LEFT END PROFILE / ANSCHLUSS LINKS / EXTRÉMITÉ GAUCHE: **L0206L**  
ZAKOŃCZENIE PRAWO / RIGHT END PROFILE / ANSCHLUSS RECHTS / EXTRÉMITÉ DROITE: **L0206R**

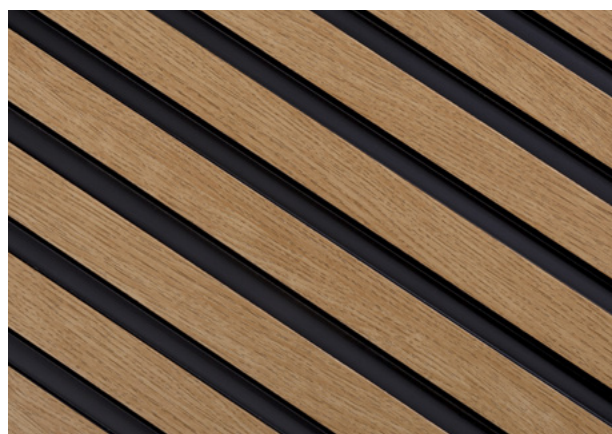
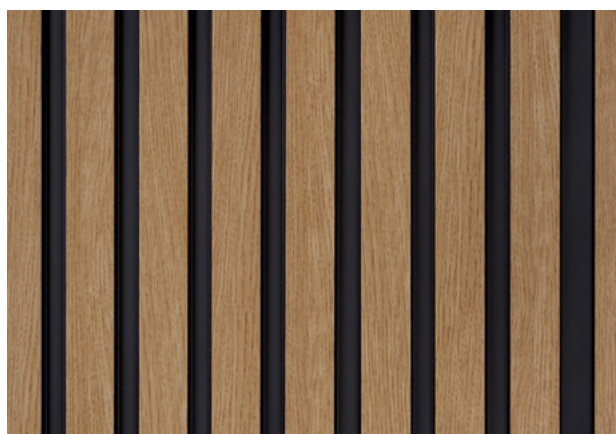
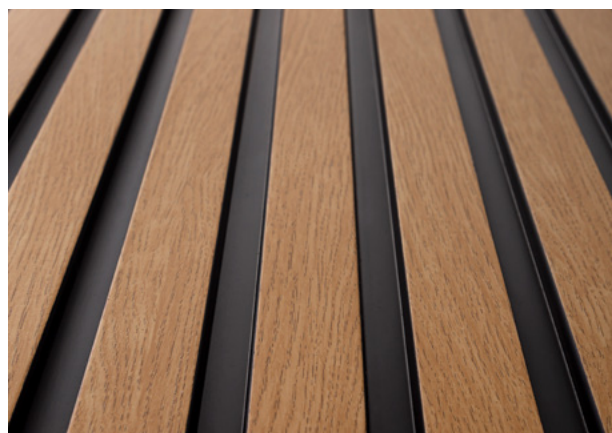

# LARGO

## KOLORY

COLOURS  
FARBEN  
COULEURS

---



### BIAŁY

WHITE | WEISS | BLANCHE

**L0301** - 270 cm  
**L0301T** - 200 cm



### DĄB JASNY

LIGHT OAK | EICHE HELL | CHÊNE CLAIR

**L0302** - 270 cm  
**L0302T** - 200 cm



### DĄB SZARY

GREY OAK | EICHE GRAU | CHÊNE GRIS

**L0303** - 270 cm  
**L0303T** - 200 cm



### DĄB CIEMNY

DARK OAK | EICHE DUNKEL  
| CHÊNE SOMBRE

**L0304** - 270 cm  
**L0304T** - 200 cm



### DĄB NATURALNY

NATURAL OAK | EICHE NATUR  
| CHÊNE NATUREL

**L0305** - 270 cm  
**L0305T** - 200 cm



### DĄB KLASYCZNY

CLASSIC OAK | EICHE KLASSIK  
| CHÊNE CLASSIQUE

**L0306** - 270 cm  
**L0306T** - 200 cm

## WYMIAR TECHNICZNY

TECHNICAL DIMENSION | TECHNISCHE DATEN | DIMENSIONS TECHNIQUES

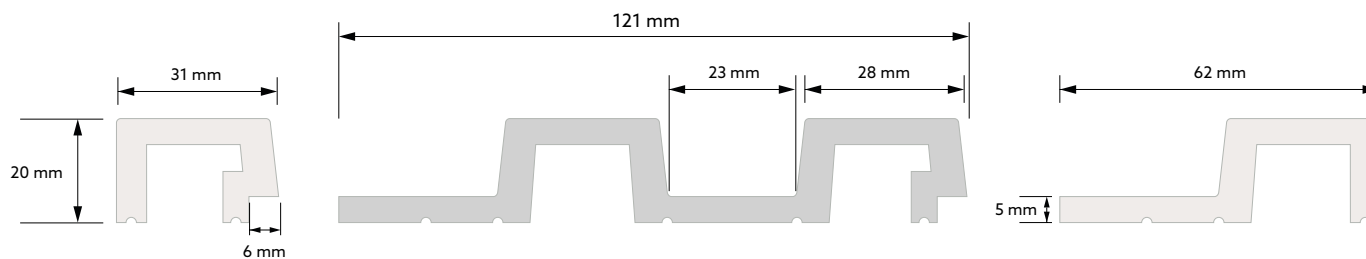

## ZAKOŃCZENIE LEWE

LEFT END PROFILE  
ANSCHLUSS LINKS  
EXTRÉMITÉ GAUCHE

## LAMELA

WALL PANEL  
WANDPANEEL  
LAMELLE

## ZAKOŃCZENIE PRAWO

RIGHT END PROFILE  
ANSCHLUSS RECHTS  
EXTRÉMITÉ DROITE

## WYMIAR PO MONTAŻU

DIMENSION AFTER ASSEMBLY | ABMESSUNG NACH DER MONTAGE | DIMENSIONS APRÈS MONTAGE

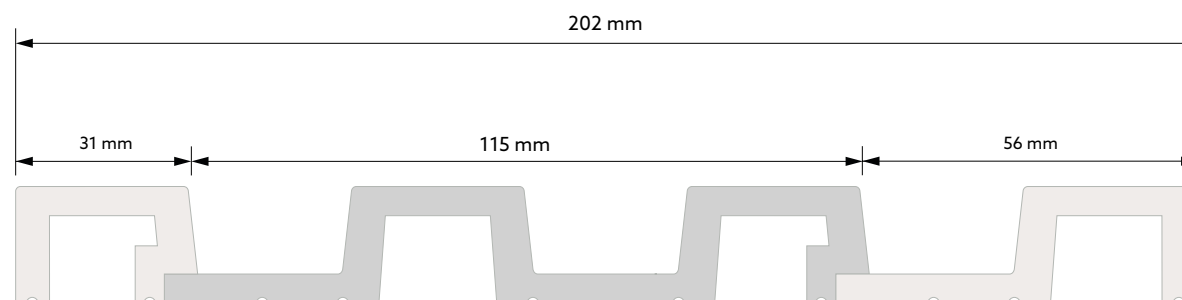

## ZAKOŃCZENIE LEWE

LEFT END PROFILE  
ANSCHLUSS LINKS  
EXTRÉMITÉ GAUCHE

## LAMELA

WALL PANEL  
WANDPANEEL  
LAMELLE

## ZAKOŃCZENIE PRAWO

RIGHT END PROFILE  
ANSCHLUSS RECHTS  
EXTRÉMITÉ DROITE

KOLEKCJA / COLLECTION / KOLLEKTION / COLLECTION: **LARGO**

KOLOR / COLOUR / FARBE / COULEUR: **BIAŁY / WHITE / WEISS / BLANCHE**

LAMELA / WALL PANEL / WANDPANEEL / LAMELLE: **L0301**

ZAKOŃCZENIE LEWE / LEFT END PROFILE / ANSCHLUSS LINKS / EXTRÉMITÉ GAUCHE: **L0301L**

ZAKOŃCZENIE PRAWE / RIGHT END PROFILE / ANSCHLUSS RECHTS / EXTRÉMITÉ DROITE: **L0301R**

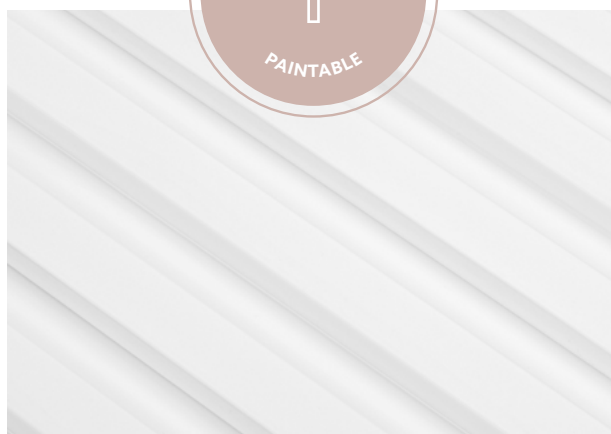



KOLEKCJA / COLLECTION / KOLLEKTION / COLLECTION: **LARGO**

KOLOR / COLOUR / FARBE / COULEUR: **DĄB JASNY / LIGHT OAK / EICHE HELL / CHÊNE CLAIR**

LAMELA / WALL PANEL / WANDPANEEL / LAMELLE: **L0302**

ZAKOŃCZENIE LEWE / LEFT END PROFILE / ANSCHLUSS LINKS / EXTRÉMITÉ GAUCHE: **L0302L**

ZAKOŃCZENIE PRAWO / RIGHT END PROFILE / ANSCHLUSS RECHTS / EXTRÉMITÉ DROITE: **L0302R**

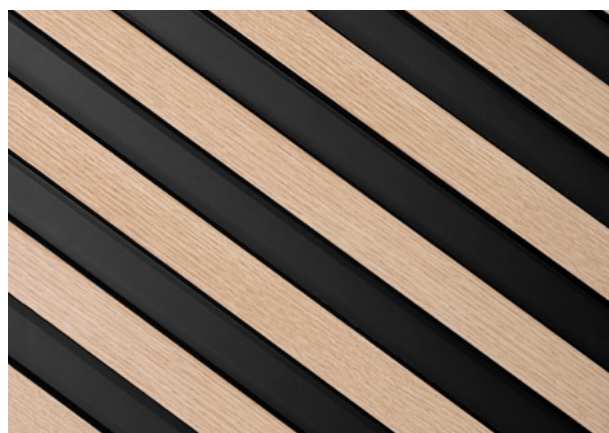

KOLEKCJA / COLLECTION / KOLLEKTION / COLLECTION: **LARGO**

KOLOR / COLOUR / FARBE / COULEUR: **DĄB SZARY / GREY OAK / EICHE GRAU / CHÊNE GRIS**

LAMELA / WALL PANEL / WANDPANEEL / LAMELLE: **L0303**

ZAKOŃCZENIE LEWE / LEFT END PROFILE / ANSCHLUSS LINKS / EXTRÉMITÉ GAUCHE: **L0303L**

ZAKOŃCZENIE PRAWO / RIGHT END PROFILE / ANSCHLUSS RECHTS / EXTRÉMITÉ DROITE: **L0303R**

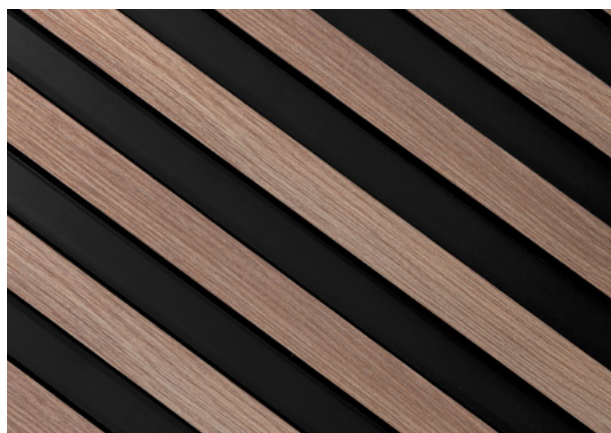
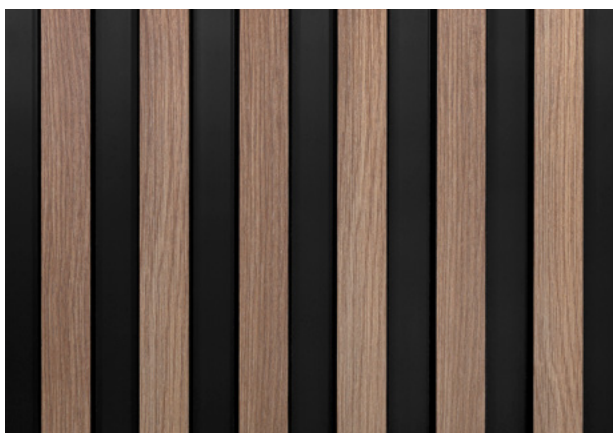
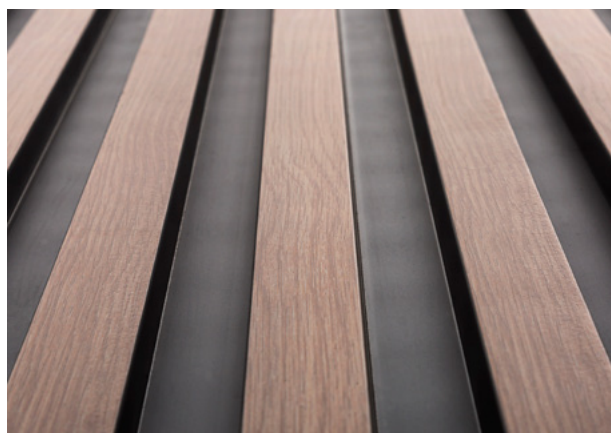

KOLEKCJA / COLLECTION / KOLLEKTION / COLLECTION: **LARGO**  
KOLOR / COLOUR / FARBE / COULEUR: **DĄB CIEMNY / DARK OAK / EICHE DUNKEL / CHÊNE SOMBRE**  
LAMELA / WALL PANEL / WANDPANEEL / LAMELLE: **L0304**  
ZAKOŃCZENIE LEWE / LEFT END PROFILE / ANSCHLUSS LINKS / EXTRÉMITÉ GAUCHE: **L0304L**  
ZAKOŃCZENIE PRAWO / RIGHT END PROFILE / ANSCHLUSS RECHTS / EXTRÉMITÉ DROITE: **L0304R**

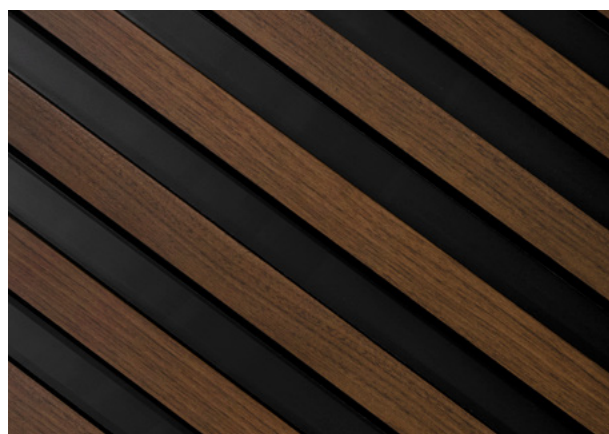
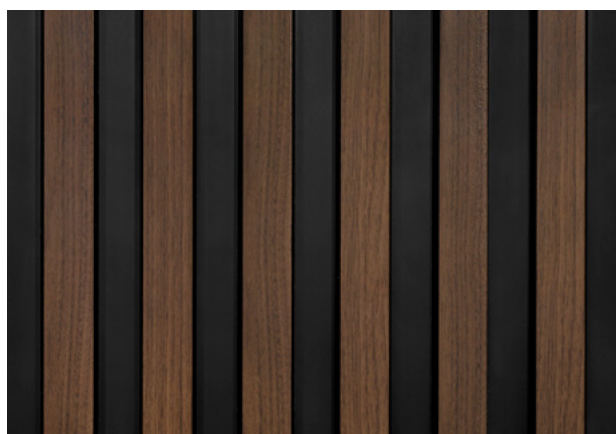

KOLEKCJA / COLLECTION / KOLLEKTION / COLLECTION: **LARGO**  
KOLOR / COLOUR / FARBE / COULEUR: **DĄB NATURALNY / NATURAL OAK / EICHE NATUR / CHÊNE NATUREL**  
LAMELA / WALL PANEL / WANDPANEEL / LAMELLE: **L0305**  
ZAKOŃCZENIE LEWE / LEFT END PROFILE / ANSCHLUSS LINKS / EXTRÉMITÉ GAUCHE: **L0305L**  
ZAKOŃCZENIE PRAWO / RIGHT END PROFILE / ANSCHLUSS RECHTS / EXTRÉMITÉ DROITE: **L0305R**

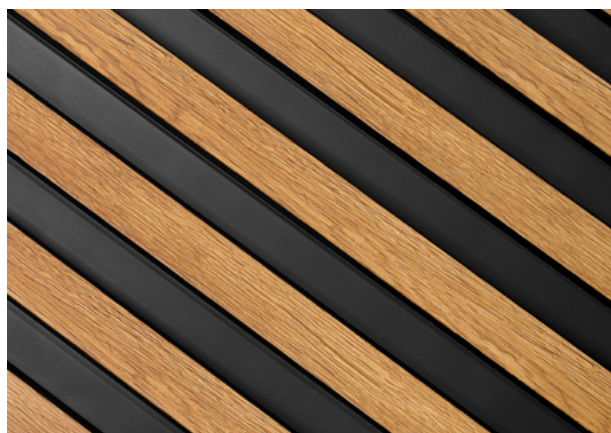
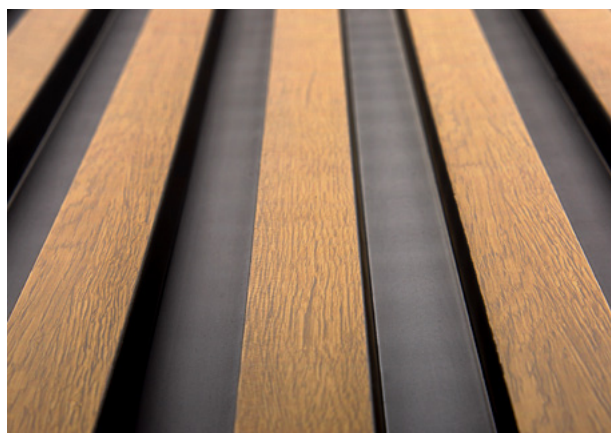

KOLEKCJA / COLLECTION / KOLLEKTION / COLLECTION: **LARGO**

KOLOR / COLOUR / FARBE / COULEUR: **DĄB KLASYCZNY / CLASSIC OAK / EICHE KLASSIK / CHÊNE CLASSIQUE**

LAMELA / WALL PANEL / WANDPANEEL / LAMELLE: **L0306**

ZAKOŃCZENIE LEWE / LEFT END PROFILE / ANSCHLUSS LINKS / EXTRÉMITÉ GAUCHE: **L0306L**

ZAKOŃCZENIE PRAWE / RIGHT END PROFILE / ANSCHLUSS RECHTS / EXTRÉMITÉ DROITE: **L0306R**

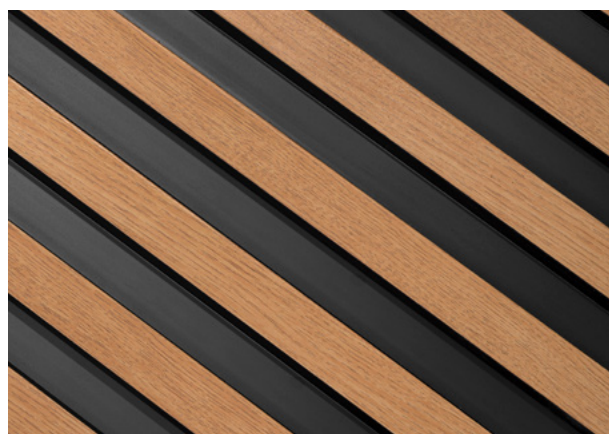
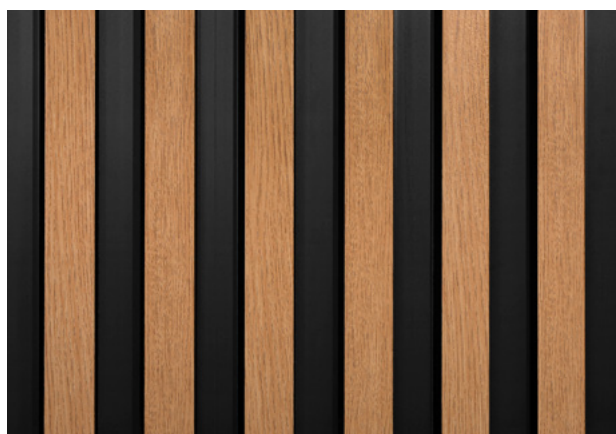
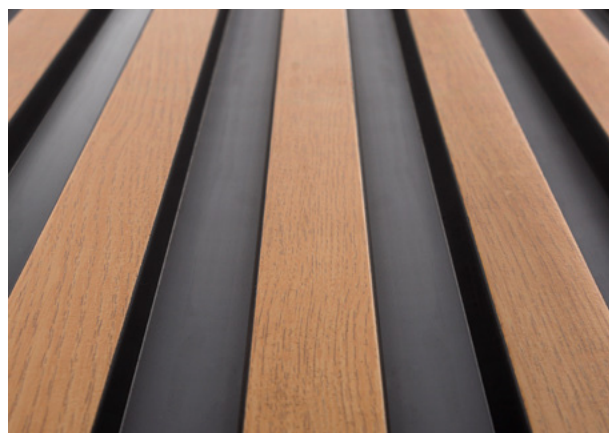



# Panele ściienne

WALL PANELS | WANDPANEEL | PANNEAUX MURAUX

## pl

**Panele ściienne to najmodniejsze rozwiązanie do dekorowania wybranych przestrzeni wnętrza. Przy ich użyciu ozdobisz nie tylko ściany, ale też inne powierzchnie, takie jak wyspy kuchenne czy fronty mebli. Ich parametry użytkowe pozwalają na montaż we wszystkich pomieszczeniach: łazienkach, pokojach dziecięcych, czy w obiektach komercyjnych. Z łatwością dostosujesz je do wystroju swojego domu, malując na dowolny kolor, czy wybierając pasujący rozmiar.**

## de

Wandpaneel sind die modischste Lösung, um ausgewählte Innenräume zu dekorieren. Damit können Sie nicht nur die Wände, sondern auch andere Oberflächen wie Kücheninseln oder Möbelfronten dekorieren. Ihre Nutzungsparameter ermöglichen die Montage in allen Räumen: Badezimmern, Kinderzimmern oder in gewerblichen Einrichtungen. Sie können die Wandpaneel ganz einfach an die Einrichtung Ihres Hauses anpassen, indem Sie entsprechende Paneelgröße wählen oder sie in beliebiger Farbe streichen.

1. WP002

## en

Wall panels are the most fashionable solution for decorating selected interior spaces. They can be used not only to decorate walls, but also other surfaces such as kitchen islands or furniture fronts. Their performance parameters allow them to be installed in any room: bathrooms, children's rooms or commercial premises. You can easily adapt them to the décor of your home by painting them in any colour and choosing the right size.

## fr

Les panneaux muraux sont une solution tendance pour décorer des parties de l'intérieur choisies. Ils peuvent être utilisés pour décorer les murs, mais aussi d'autres surfaces à savoir les îlots de cuisine ou les façades de meubles. Leurs paramètres de performance permettent de les installer dans la totalité des pièces : salles de bains, chambres d'enfants ou locaux commerciaux. Ils sont facilement adaptables au décor de votre intérieur, peints d'une couleur de votre choix ou taillés de dimensions souhaitées.



pl

**Maksymalne utwardzenie powierzchni**

dzięki technologii ScratchShield

**Odporne na działanie wody**

bez efektu pęcznienia i rozwarstwiania

**Idealne dopasowanie elementów**

bez widocznych łączeń między panelami

**Możliwość malowania na dowolny kolor**

przy użyciu farby wodnej

en

**Maximum surface hardness**

thanks to the ScratchShield technology

**Water and moisture resistant**

with no swelling and delamination

**Perfect fit of elements**

with no visible joints between panels

**Can be painted in any colour**

using watercolour

de

**Maximale Oberflächenhärtung**

dank der ScratchShield-Technologie

**Wasser- und feuchtigkeitsbeständig**

ohne Quellen und Delaminierung

**Perfekter Sitz der Elemente**

keine sichtbaren Verbindungen zwischen den Paneelen

**Möglichkeit, Paneele in jeder Farbe zu malen**

mit Wasserfarbe

fr

**Durcissement maximal de la surface**

grâce à la technologie ScratchShield

**Résistance à l'eau et à l'humidité**

sans effet de gonflement ni de délamination

**Alignement parfait des éléments**

sans fentes visibles entre les panneaux

**Peut être peint à une couleur de votre choix**

à une peinture à l'eau



**pl** **Poprawa akustyki  
we wnętrzu**  
wygłuszenie echa  
i pogłosów

**Łatwy i szybki  
montaż**  
do samodzielnego  
wykonania

**Panele pokryte  
primerem**  
ułatwiającym  
rozprowadzenie farby

**Idealnie  
wyprofilowany kształt**  
dzięki najnowocześniejszej  
technologii produkcji

**en** **Improved room acoustics**  
reduced echo and reverberation

**Quick and easy installation**  
do-it-yourself installation

**Primed panels**  
for easy painting

**Perfectly contoured shape**  
thanks to a state-of-the-art manufac-  
turing technology

**de** **Verbesserung der Innenakustik**  
Reduktion von Echo und Nachhall

**Einfache und schnelle Installation**  
DIY

**Panele mit Primer beschichtet**  
für leichteres Auftragen der Farbe

**Perfekt geformt**  
dank modernster Fertigungstechnik

**fr** **Amélioration du confort acoustique**  
réduction des échos et des réverbéra-  
tions

**Assemblage facile et rapide**  
à exécuter soi-même

**Panneaux revêtus d'une couche d'ap-  
prêt**  
pour application facile de la peinture

**Parfaitement préformés**  
grâce à une technologie de production  
de pointe





# Duna

COLLECTION



## PANEL ŚCIENNY

WALL PANEL | WANDPANEEL | PANNEAU DE MUR

**WP001** - 270 cm

**WP001T** - 200 cm

PolyForce® | ScratchShield®



## ZAKOŃCZENIA

END PROFILES | ABSCHLUSSPROFILE | PROFIL FINAL

LEWE | LEFT | LINKE | GAUCHE

**WP001L** - 270 cm

**WP001LT** - 200 cm

PolyForce® | ScratchShield®

PRAWE | RIGHT | RECHTE | DROIT

**WP001R** - 270 cm

**WP001RT** - 200 cm

PolyForce® | ScratchShield®

## WYMIAR TECHNICZNY

TECHNICAL DIMENSION | TECHNISCHE DATEN | DIMENSIONS TECHNIQUES

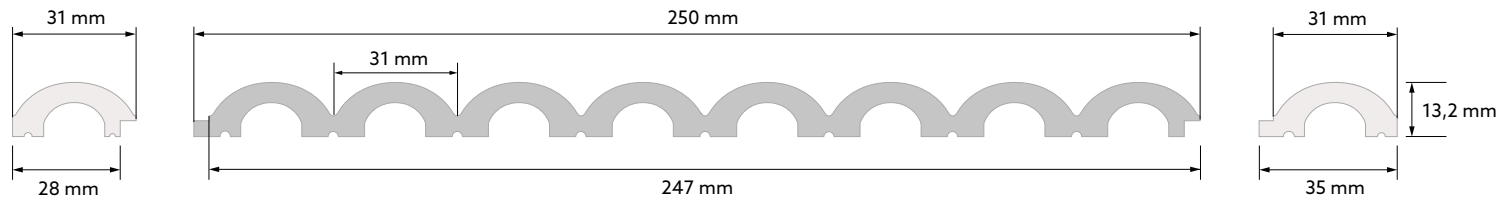

ZAKOŃCZENIE LEWE

LEFT END PROFILE  
ANSCHLUSS LINKS  
EXTRÉMITÉ GAUCHE

PANEL

WALL PANEL  
WANDPANEEL  
LAMELLE

ZAKOŃCZENIE PRAWO

RIGHT END PROFILE  
ANSCHLUSS RECHTS  
EXTRÉMITÉ DROITE

## WYMIAR PO MONTAŻU

DIMENSION AFTER ASSEMBLY | ABMESSUNG NACH DER MONTAGE | DIMENSIONS APRÈS MONTAGE

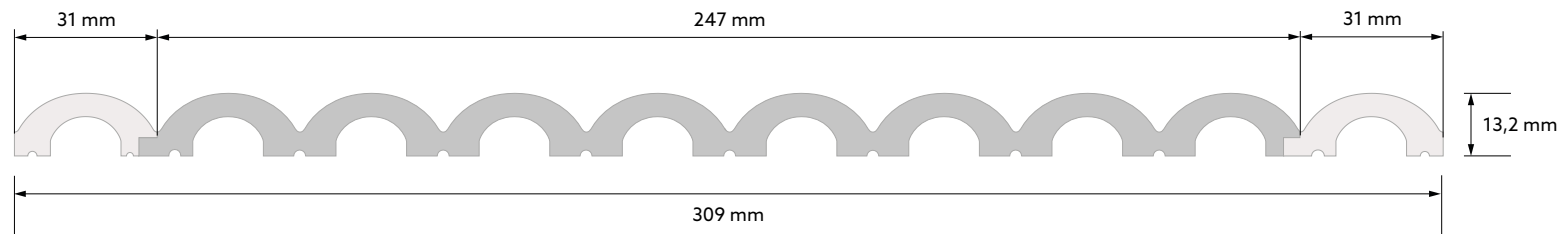

ZAKOŃCZENIE LEWE

LEFT END PROFILE  
ANSCHLUSS LINKS  
EXTRÉMITÉ GAUCHE

PANEL

WALL PANEL  
WANDPANEEL  
LAMELLE

ZAKOŃCZENIE PRAWO

RIGHT END PROFILE  
ANSCHLUSS RECHTS  
EXTRÉMITÉ DROITE

# Lumio

COLLECTION



## PANEL ŚCIENNY

WALL PANEL | WANDPANEEL | PANNEAU DE MUR

**WP002** - 270 cm

**WP002T** - 200 cm

PolyForce® | ScratchShield®



## ZAKOŃCZENIA

END PROFILES | ABSCHLUSSPROFILE | PROFIL FINAL

LEWE | LEFT | LINKE | GAUCHE

**WP002L** - 270 cm

**WP002LT** - 200 cm

PolyForce® | ScratchShield®

PRAWE | RIGHT | RECHTE | DROIT

**WP002R** - 270 cm

**WP002RT** - 200 cm

PolyForce® | ScratchShield®

## WYMIAR TECHNICZNY

TECHNICAL DIMENSION | TECHNISCHE DATEN | DIMENSIONS TECHNIQUES

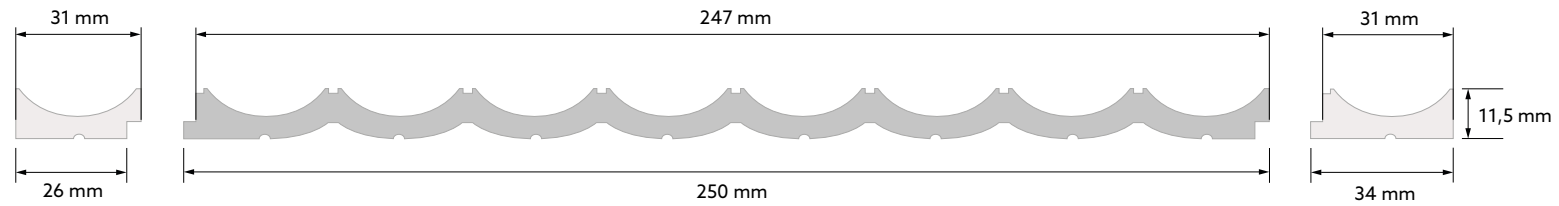

ZAKOŃCZENIE LEWE

LEFT END PROFILE  
ANSCHLUSS LINKS  
EXTRÉMITÉ GAUCHE

PANEL

WALL PANEL  
WANDPANEEL  
LAMELLE

ZAKOŃCZENIE PRAWO

RIGHT END PROFILE  
ANSCHLUSS RECHTS  
EXTRÉMITÉ DROITE

## WYMIAR PO MONTAŻU

DIMENSION AFTER ASSEMBLY | ABMESSUNG NACH DER MONTAGE | DIMENSIONS APRÈS MONTAGE

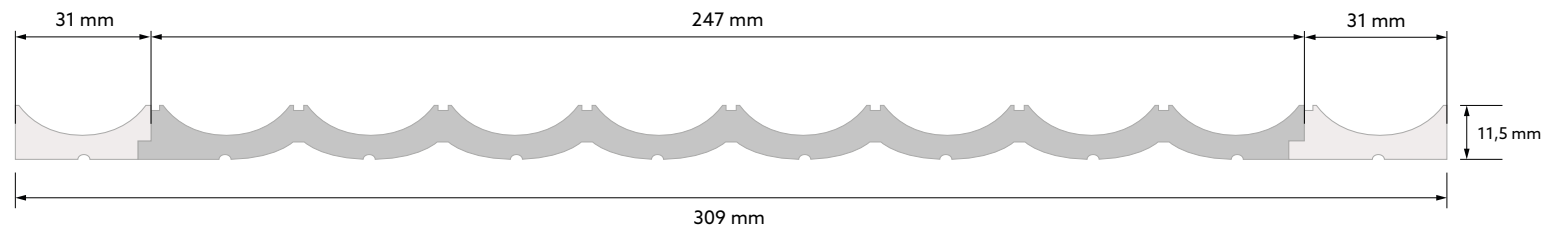

ZAKOŃCZENIE LEWE

LEFT END PROFILE  
ANSCHLUSS LINKS  
EXTRÉMITÉ GAUCHE

PANEL

WALL PANEL  
WANDPANEEL  
LAMELLE

ZAKOŃCZENIE PRAWO

RIGHT END PROFILE  
ANSCHLUSS RECHTS  
EXTRÉMITÉ DROITE

# Dekoracje

DECORATIVE ELEMENTS | ZIERELEMENTE | ÉLÉMENTS DÉCORATIFS

1

## pl

**Dzięki elementom dekoracyjnym Mardom Decor uzupełnisz aranżację swojego wnętrza. Wsporniki, dekory i obramowania wykonane są z wodoodpornego i trwałego materiału ProFoam, którego gęstość pozwala na stworzenie głębokich i wyraźnych zdobień. Wszystkie elementy pokryte są białym primerem, który ułatwia wchłanianie kolejnych warstw farby.**

## de

Ergänzen Sie Ihre Inneneinrichtung mit Elementen von Mardom Decor. Alle Profile sind aus wasserfestem und haltbarem ProFoam-Material gefertigt, dessen Dichte es ermöglicht, tiefe und klare Reliefs abzubilden. Alle Elemente sind mit einer weißen Grundierung versehen, die die Aufnahme des Endanstrichs erleichtert.

## en

With Mardom Decor decorative elements you will complement the design of your interior. Brackets, decors and surrounds are made of waterproof and durable ProFoam material, whose density allows to create deep-cut and distinct decorations. All elements are treated with a white primer, which facilitates the absorption of subsequent layers of paint.

## fr

Grâce aux éléments décoratifs Mardom Decor, vous complétez votre aménagement intérieur. Les supports, décors et ornements sont en matériau ProFoam étanche et durable, dont la densité permet la création de décorations profondes et claires. Tous les éléments sont recouverts d'un apprêt blanc, ce qui facilite l'absorption des couches de peinture suivantes.



MD318-10  
+ MD318

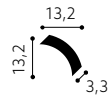

PolyForce®

13,2 x 13,2 x 3,3 x 1,5 cm

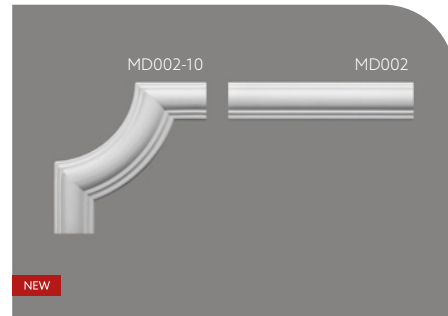

MD002-10  
+ MD002

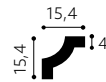

PolyForce®

15,4 x 15,4 x 4 x 1,8 cm

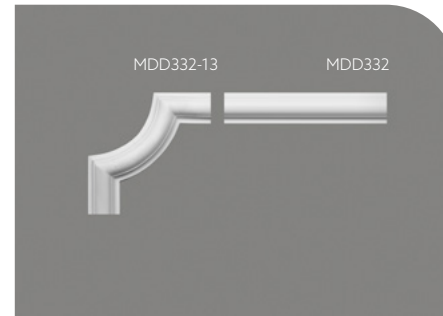

MDD332-13  
+ MDD332

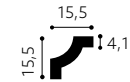

ProFoam®

15,5 x 15,5 x 4,1 x 1,7 cm

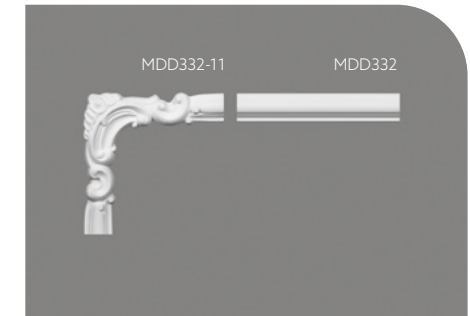

MDD332-11  
+ MDD332

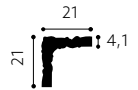

ProFoam®

21 x 21 x 4,1 x 1,7 cm

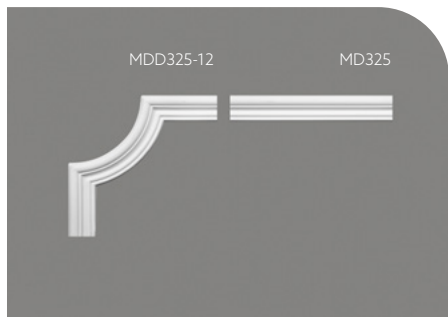

MDD325-12  
+ MD325

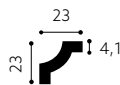

ProFoam®

23 x 23 x 4,1 x 1,5 cm

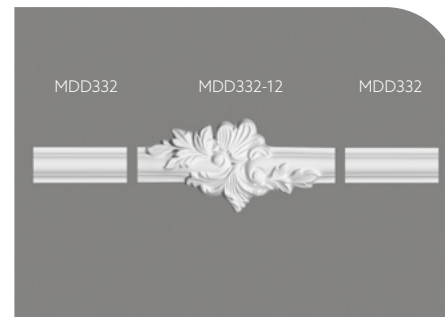

MDD332-12  
+ MDD332



ProFoam®

23,5 x 11 x 4,1 x 1,7 cm

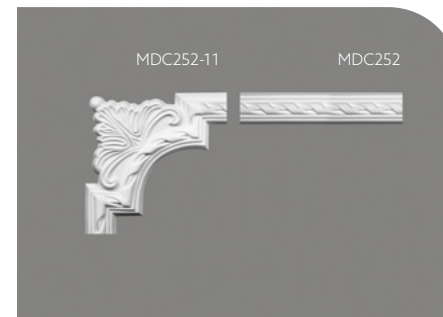

MDC252-11  
+ MDC252

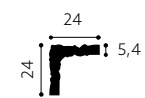

ProFoam®

24 x 24 x 5,4 x 2,3 cm

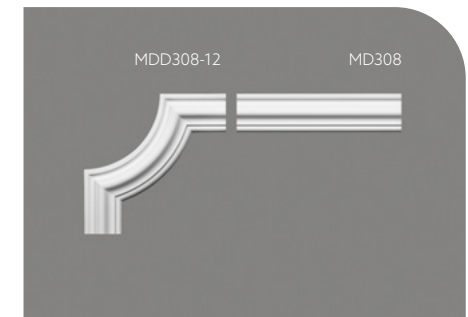

MDD308-12  
+ MD308

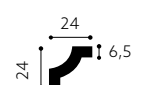

ProFoam®

24 x 24 x 6,5 x 2,1 cm

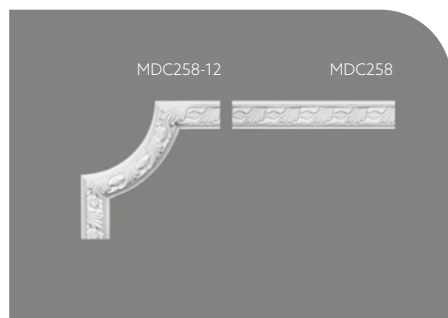

MDC258-12  
+ MDC258

ProFoam®

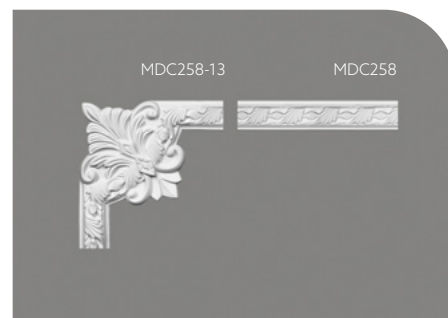
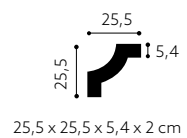

MDC258-13  
+ MDC258

ProFoam®

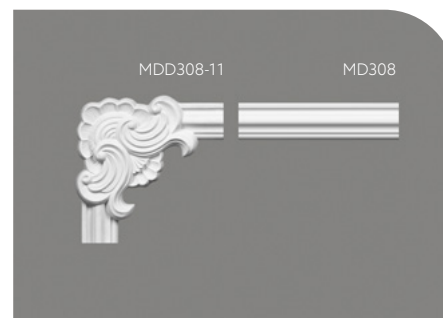
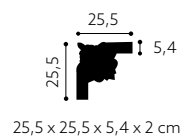

MDD308-11  
+ MD308

ProFoam®

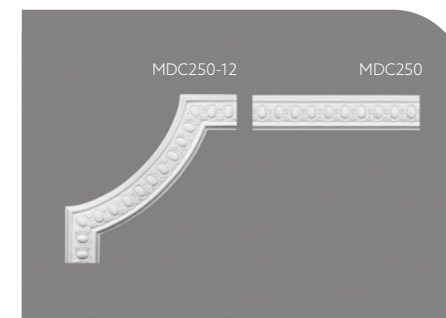
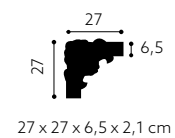

MDC250-12  
+ MDC250

ProFoam®

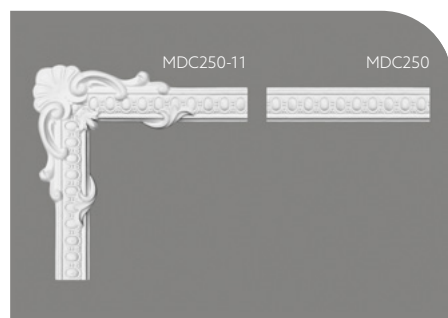
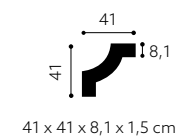

MDC250-11  
+ MDC250

ProFoam®

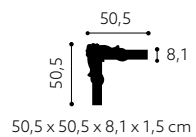





1. MDB117

2. MD325

3. MD002

4. MD014

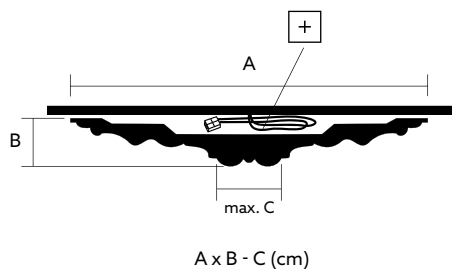

**B3110**  
 Ø 9,4 x 1,8 cm  
 ProFoam®

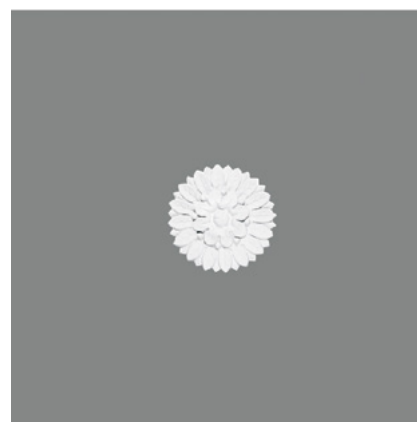

**B3002**  
 Ø 15,5 x 3 cm  
 ProFoam®

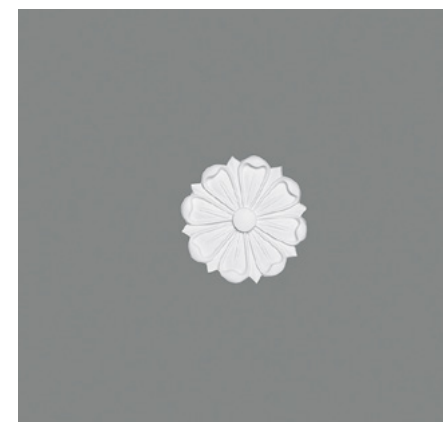

**B3021**  
 Ø 16 x 1,6 cm  
 ProFoam®



**B3014**  
 Ø 32 x 4 cm  
 ProFoam®



**B3030**  
 Ø 37,5 x 4,6 - 10 cm  
 ProFoam®



**B3029**  
 Ø 38 x 4,5 - 7,5 cm  
 ProFoam® 



**B3033**  
 Ø 49,2 x 5,4 - 14 cm  
 ProFoam® 



**QR001**  
 Ø 51,8 x 4 - 15,5 cm  
 ProFoam®



**B3020**  
 Ø 51,4 x 3,5 - 10 cm  
 ProFoam®



**B3025**  
 Ø 52,6 x 4 - 10 cm  
 ProFoam®



**QR002**  
 Ø 51,5 x 5 cm  
 ProFoam®



**QR005**  
 Ø 60 x 60 x 5 cm  
 ProFoam®



**B3047**  
 Ø 59,6 x 7 - 15 cm  
 ProFoam®



**B3023**  
 Ø 59,2 x 8,5 - 8,5 cm  
 ProFoam®



**B3038**  
 Ø 61,5 x 4 - 14 cm  
 ProFoam®



**B3050**  
 Ø 67 x 5,3 - 6,5 cm  
 ProFoam®



**B2021**  
 74,8 x 51 x 4 cm  
 ProFoam®



**B3077**  
 Ø 75,2 x 4 - 8 cm  
 ProFoam®



**B3015**  
 Ø 82,8 x 6,4 - 15 cm  
 ProFoam®

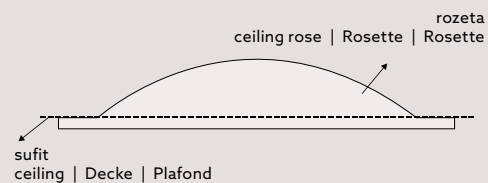

- pl** Rozety o przekroju wklęsłym - wpuszczane w sufit
- en** Rosettes with concave section - recessed into the ceiling
- de** Nach innen gewölbte Kuppel zum einlassen in die Decke
- fr** Rosaces concaves - encastrées dans le plafond



**B2002**  
 Ø 72 x 12,5 cm  
 ProFoam®



**B2003**  
 Ø 113 x 21,5 cm  
 ProFoam®



1. MDD345    2. MD314    3. MD009    4. MD094

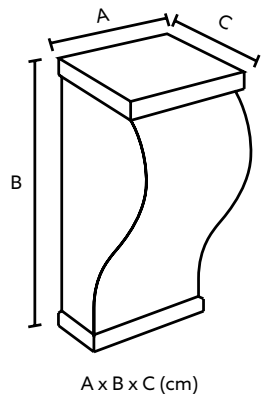

**C1000-1W**  
26,5 x 10,5 x 26,5 cm  
ProFoam®



**C1001-1W**  
30 x 11,5 x 30 cm  
ProFoam®



**C1002-1W**  
36 x 12,5 x 36 cm  
ProFoam®



**C1000-2W**  
29 x 20,7 x 29 cm  
ProFoam®



**C1001-2W**  
33 x 24,5 x 33 cm  
ProFoam®



**C1002-2W**  
37,5 x 25,7 x 37,5 cm  
ProFoam®



**C5000-4W**  
24 x 13 x 24 cm  
ProFoam®



**C5001-4W**  
28 x 14,5 x 28 cm  
ProFoam®



**C5002-4W**  
31 x 16 x 31 cm  
ProFoam®

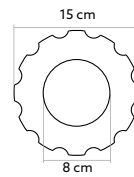
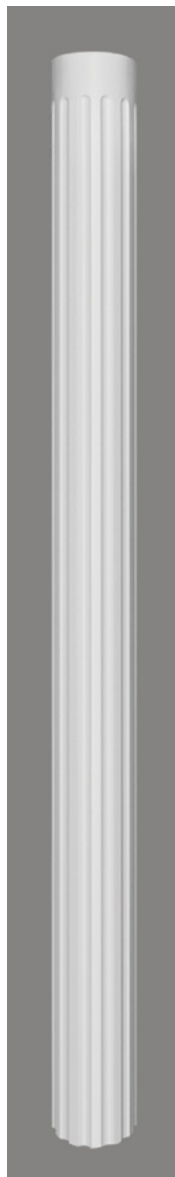

**C3000W**  
H: 239,5 cm  
ProFoam®

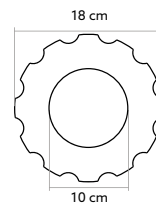

**C3001W**  
H: 239,5 cm  
ProFoam®

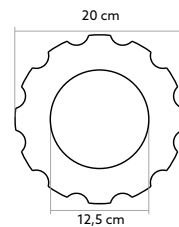

**C3002W**  
H: 239,5 cm  
ProFoam®

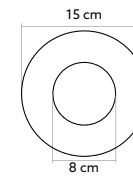

**C4000W**  
H: 242,5 cm  
ProFoam®

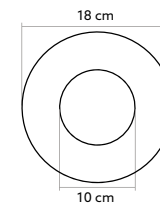

**C4001W**  
H: 242,5 cm  
ProFoam®

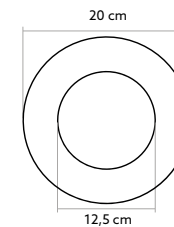

**C4002W**  
H: 242,5 cm  
ProFoam®

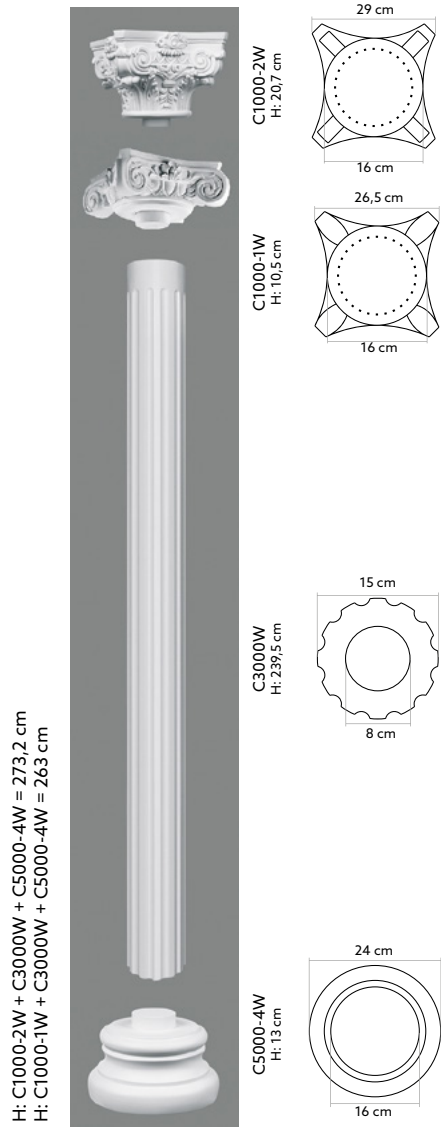

ProFoam®

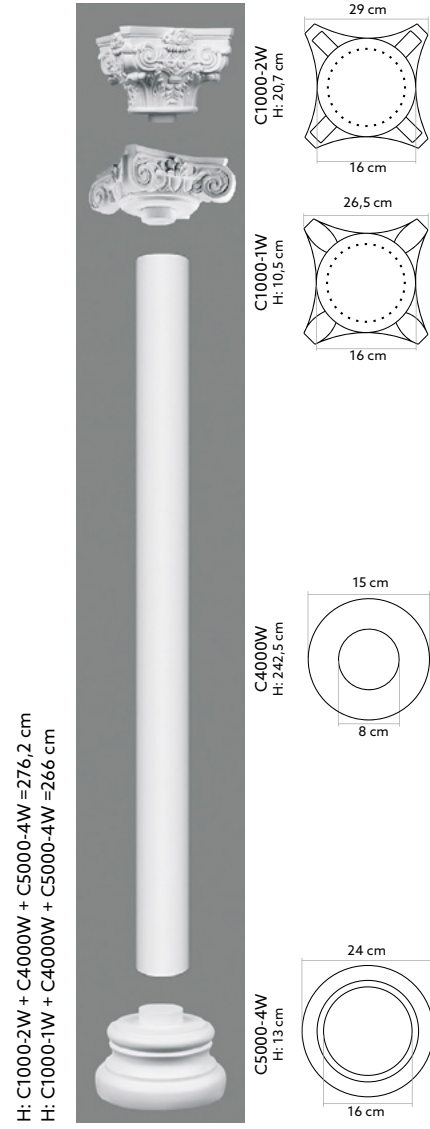

ProFoam®

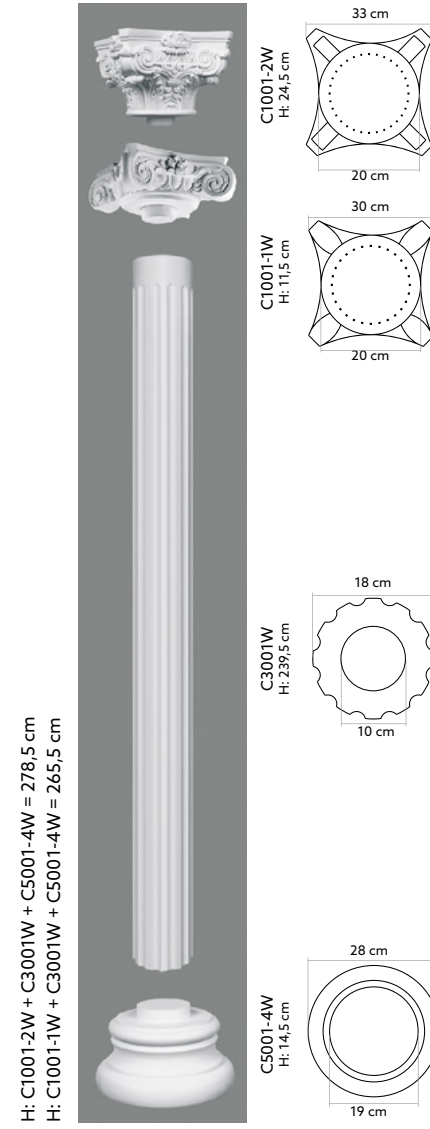

ProFoam®



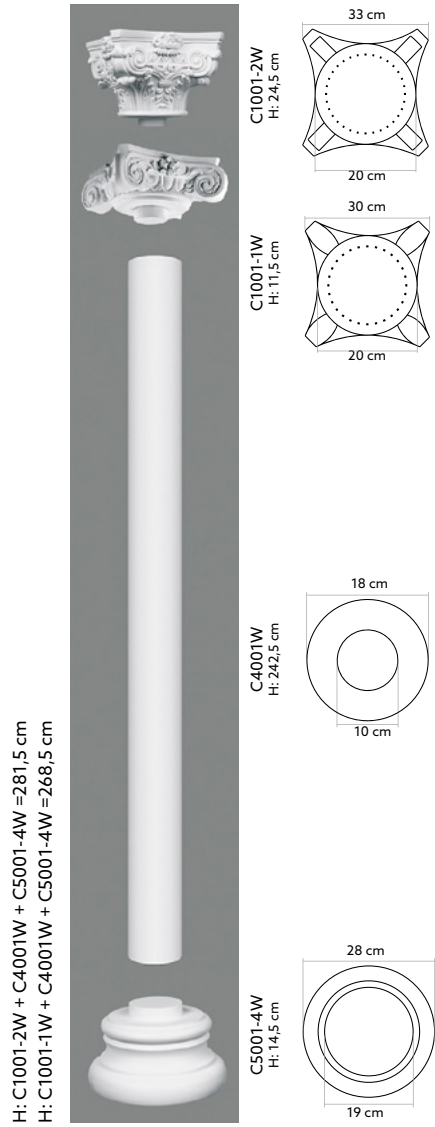

ProFoam®

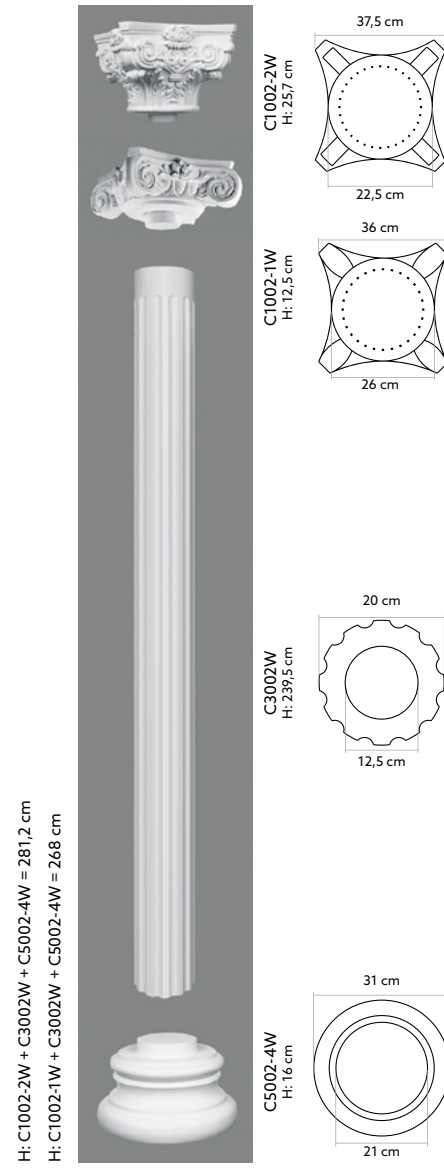

ProFoam®

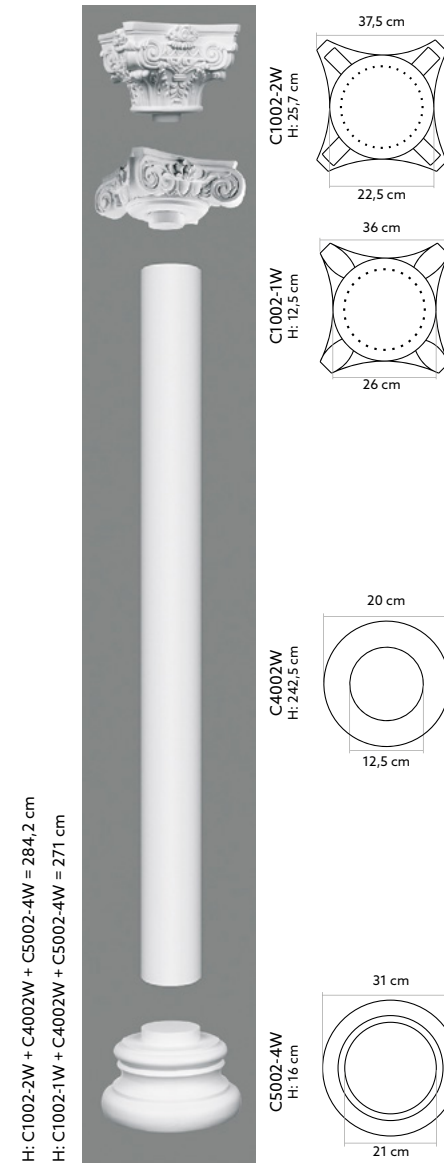

ProFoam®

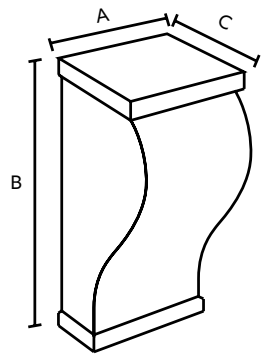

A x B x C (cm)



**C1000-1H**  
26,5 x 10,5 x 13,2 cm

ProFoam®



**C1001-1H**  
30 x 11,5 x 15 cm

ProFoam®



**C1002-1H**  
36 x 12,5 x 18 cm

ProFoam®



**C1000-2H**  
29 x 20,7 x 14,5 cm

ProFoam®



**C1001-2H**  
33 x 24,5 x 16,5 cm

ProFoam®



**C1002-2H**  
37,5 x 25,7 x 18,7 cm

ProFoam®



**C5000-4H**  
24 x 13 x 12 cm

ProFoam®



**C5001-4H**  
28 x 14,5 x 14 cm  
ProFoam®

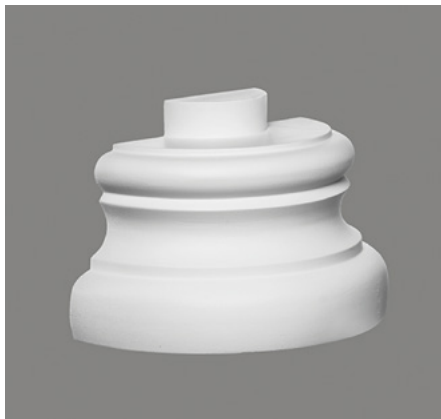

**C5002-4H**  
31 x 16 x 15,5 cm  
ProFoam®

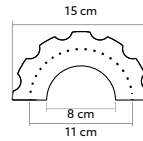
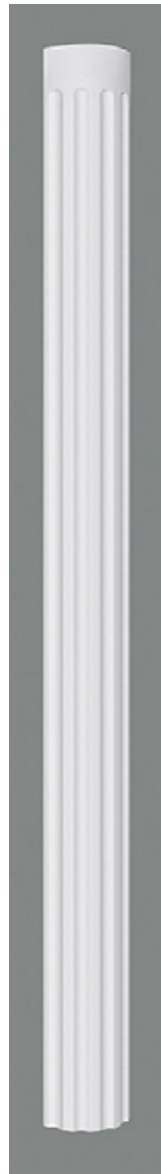

**C3000H**  
H: 239,5 cm  
ProFoam®

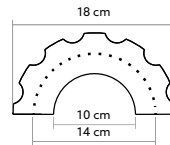

**C3001H**  
H: 239,5 cm  
ProFoam®

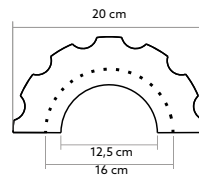

**C3002H**  
H: 239,5 cm  
ProFoam®

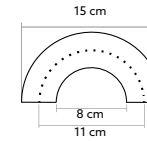

**C4000H**  
H: 242,5 cm  
ProFoam®

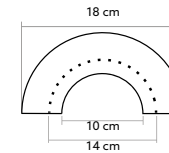

**C4001H**  
H: 242,5 cm  
ProFoam®

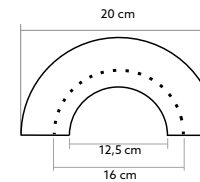

**C4002H**  
H: 242,5 cm  
ProFoam®

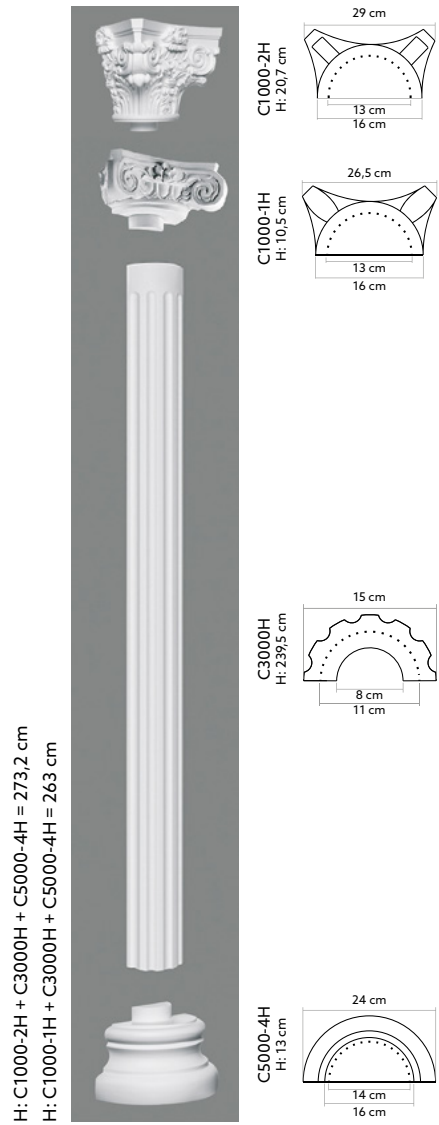

ProFoam®

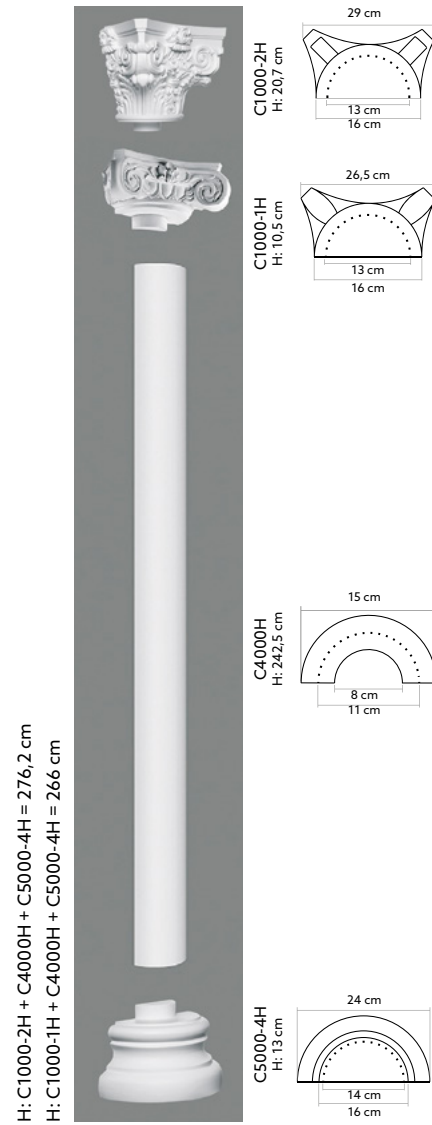

ProFoam®

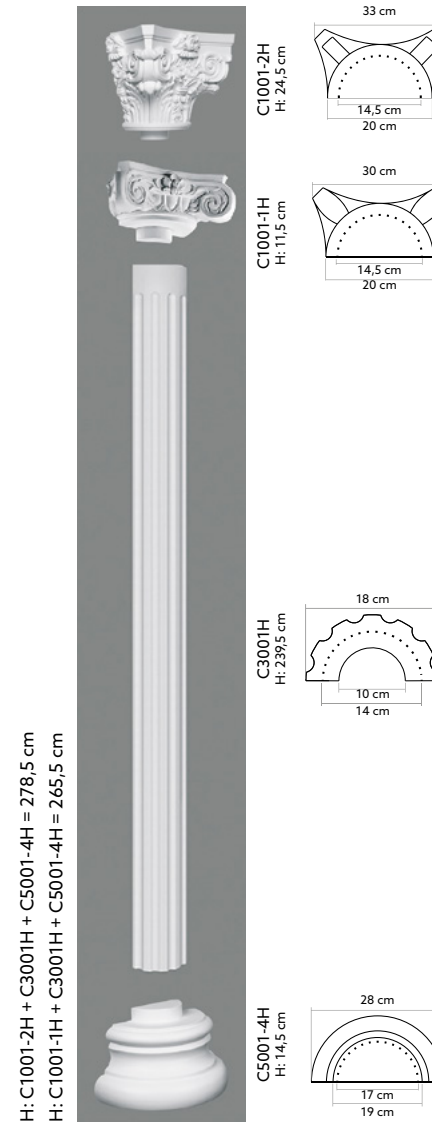

ProFoam®

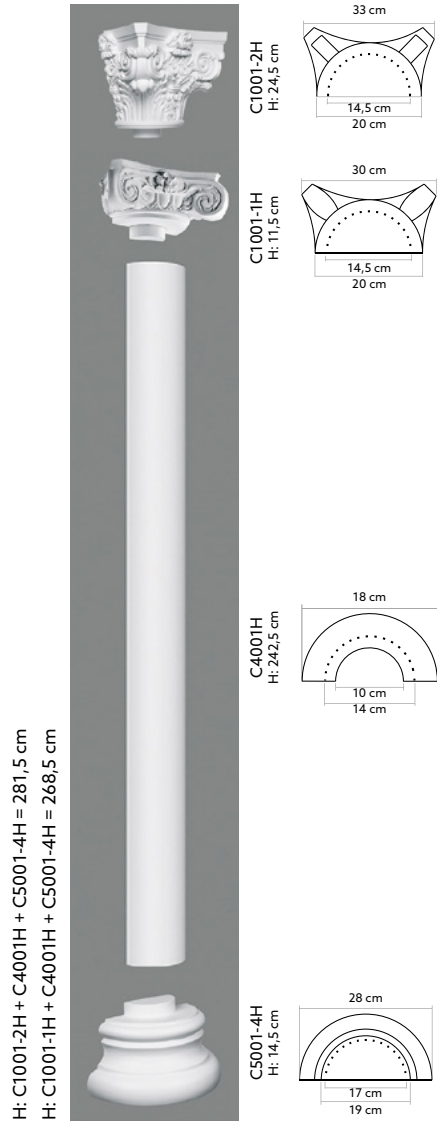

ProFoam®

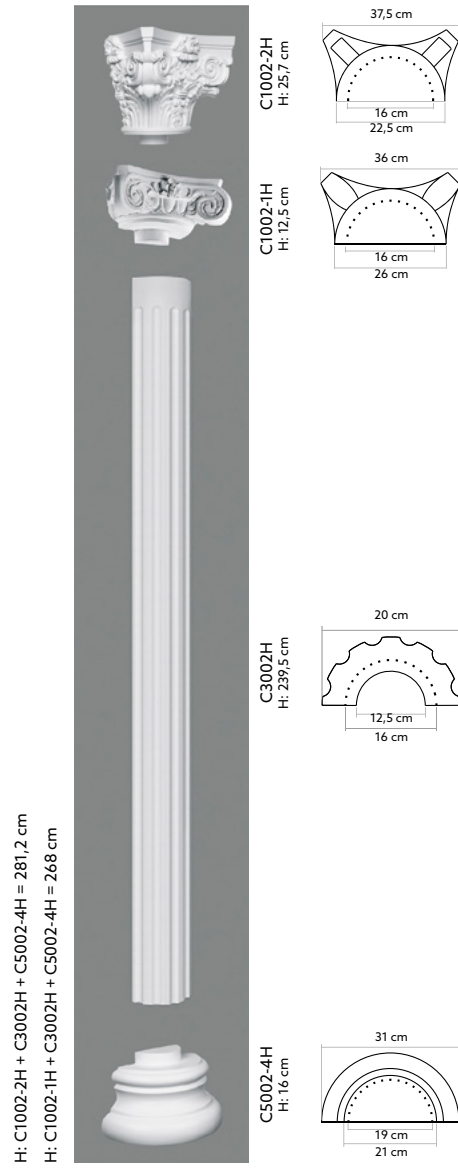

ProFoam®

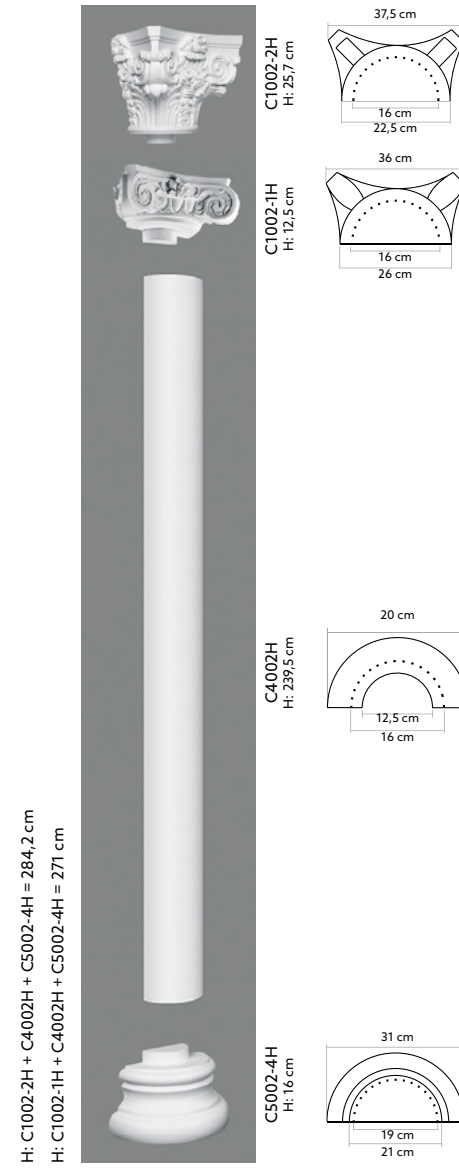

ProFoam®

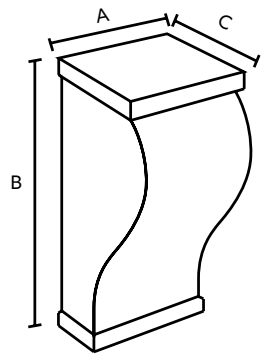

A x B x C (cm)



**D3016**  
9,7 x 9,7 x 3,5 cm  
ProFoam®

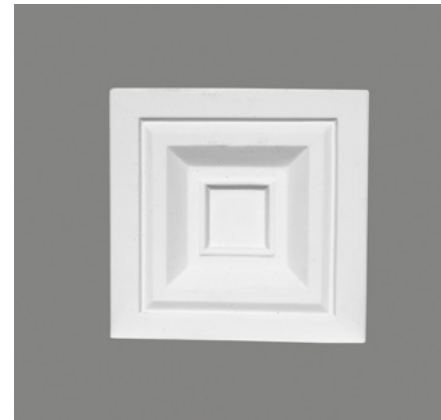

**D3542**  
9,7 x 9,7 x 3 cm  
ProFoam®



**D3543**  
9,7 x 9,7 x 4 cm  
ProFoam®



**D3008**  
26 x 8 x 7 cm  
ProFoam®



**D3023**  
44,5 x 18,2 x 6,7 cm  
ProFoam®



**D3502**  
21,5 x 13,5 x 5,5 cm  
ProFoam®



**D3533**  
31,7 x 16,8 x 8 cm  
ProFoam®



**D3503**  
31,7 x 16,8 x 8 cm  
ProFoam®



**D3505**  
40,7 x 34,5 x 9,5 cm  
ProFoam®



**D3007**  
30,8 x 17,5 x 8,8 cm  
ProFoam®



**D3024**  
33,5 x 15,8 x 7 cm  
ProFoam®



**D3544**  
9,5 x 25,2 x 3 cm  
ProFoam®



**D3509**  
14 x 29,5 x 4,5 cm  
ProFoam®



**D3012**  
11,4 x 30 x 3,3 cm  
ProFoam®



**D3011**  
13,5 x 25,5 x 3,7 cm  
ProFoam®



**D3010**  
19,5 x 35,5 x 3 cm  
ProFoam®



**D3003**  
28,8 x 64 x 6 cm  
ProFoam®



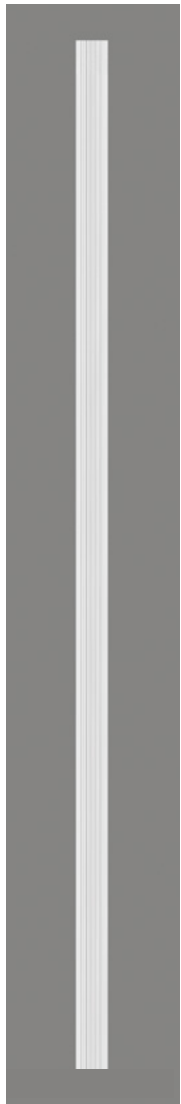

**MDD412**  
240 x 7,5 x 1,8 cm  
ProFoam®

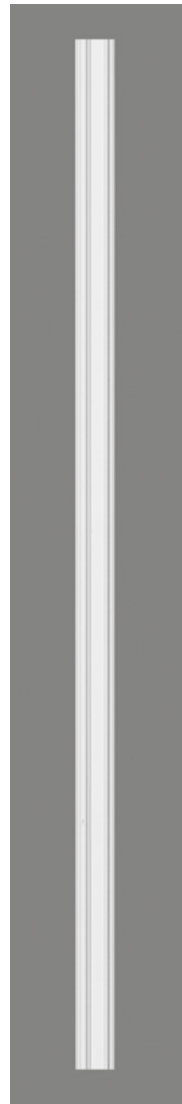

**D1511**  
240 x 9,3 x 3,2 cm  
ProFoam®

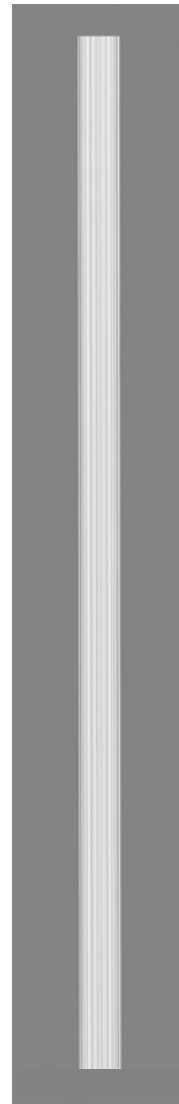

**D1541**  
240 x 9,7 x 2,2 cm  
ProFoam®

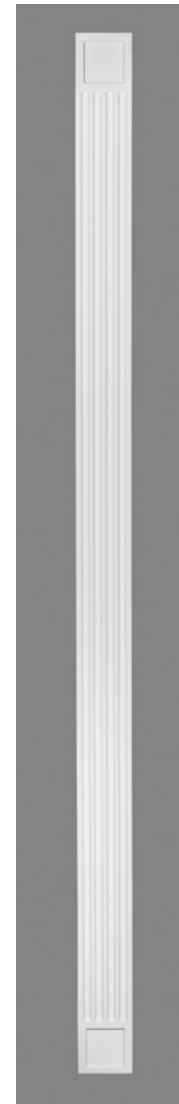

**D1500**  
240 x 13 x 2,1 cm  
ProFoam®

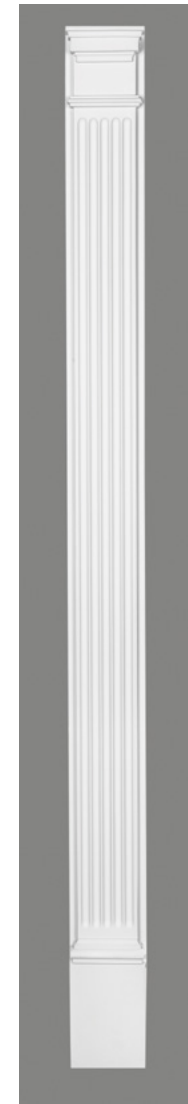

**D1504**  
216 x 16,5 x 7 cm  
ProFoam®

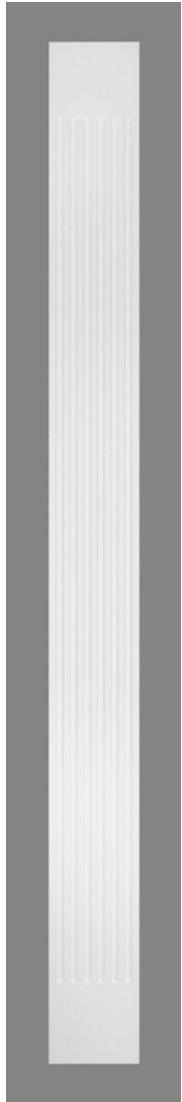

D1523  
200 x 16,5 x 1,8 cm  
ProFoam®

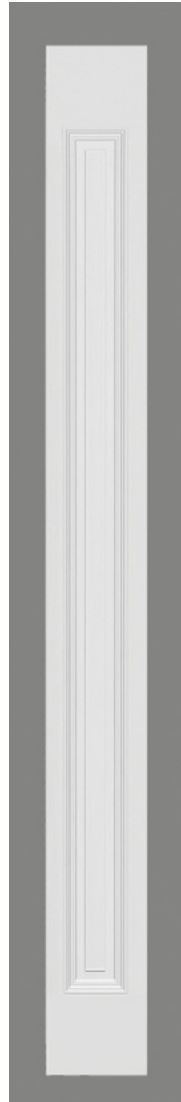

D1515  
200 x 19,7 x 2 cm  
ProFoam®

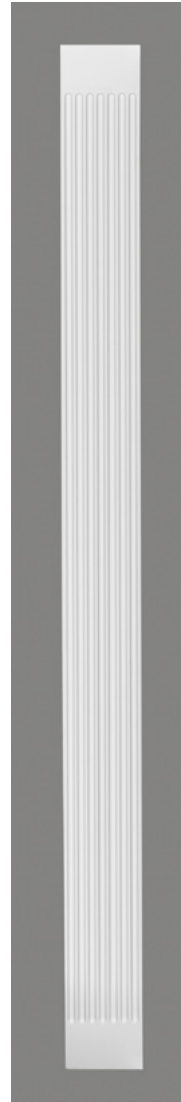

D1516  
220 x 19,7 x 2 cm  
ProFoam®

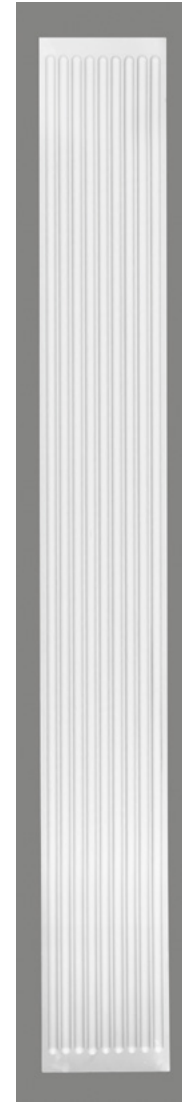

D1518  
200 x 25 x 3 cm  
ProFoam®

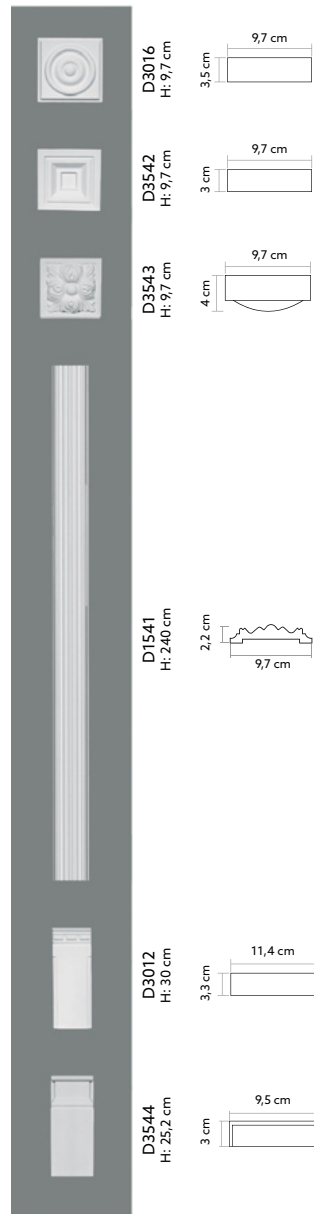

ProFoam®

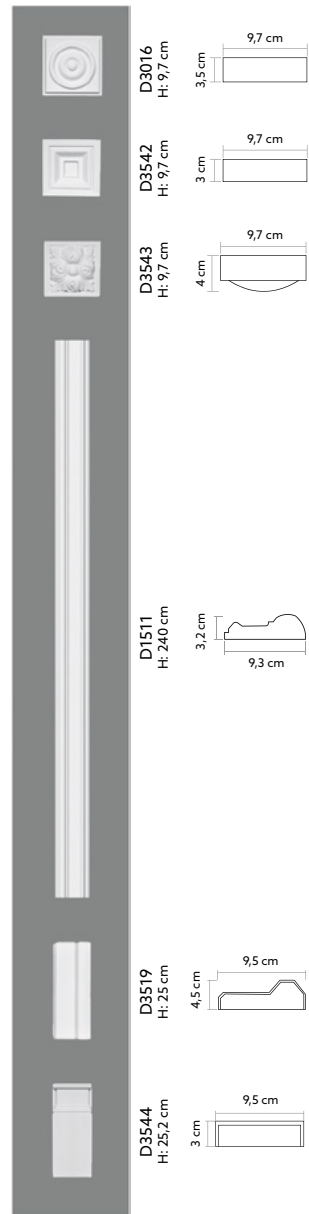

ProFoam®

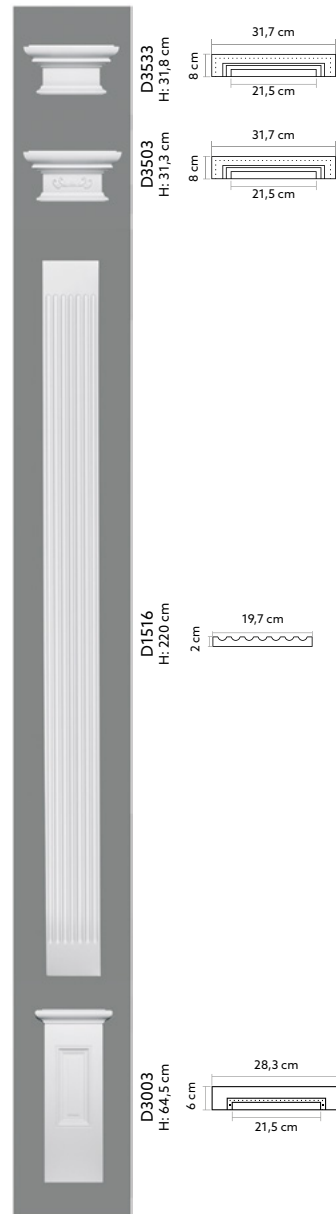

ProFoam®

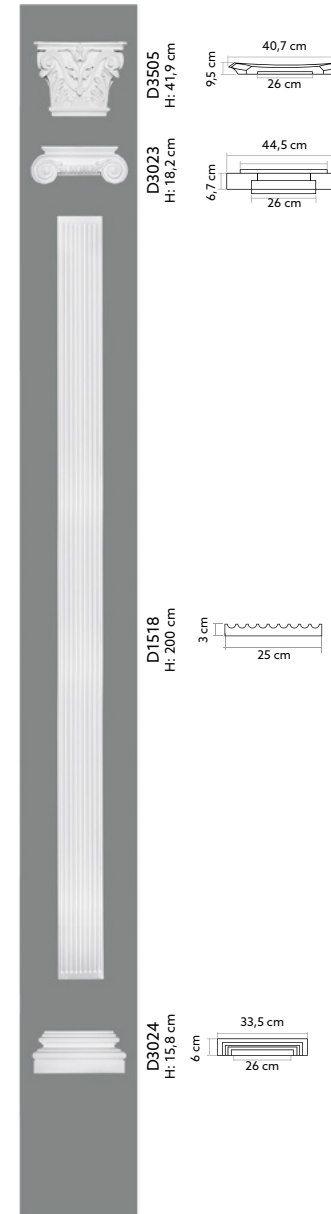

ProFoam®

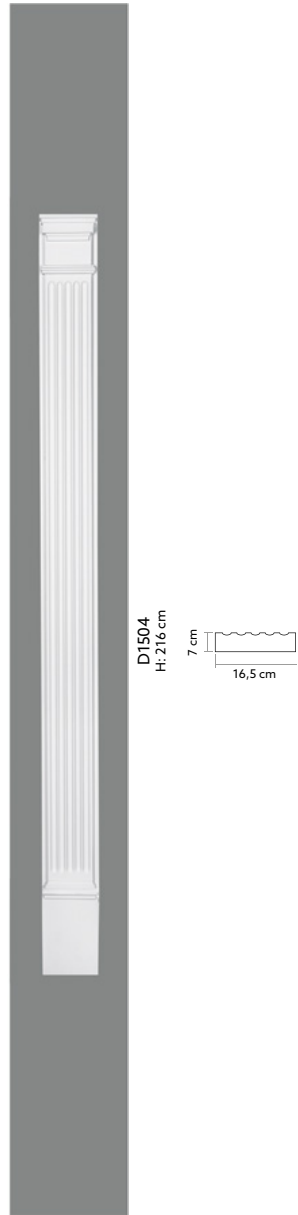

D1504  
H: 216 cm

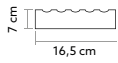

ProFoam®

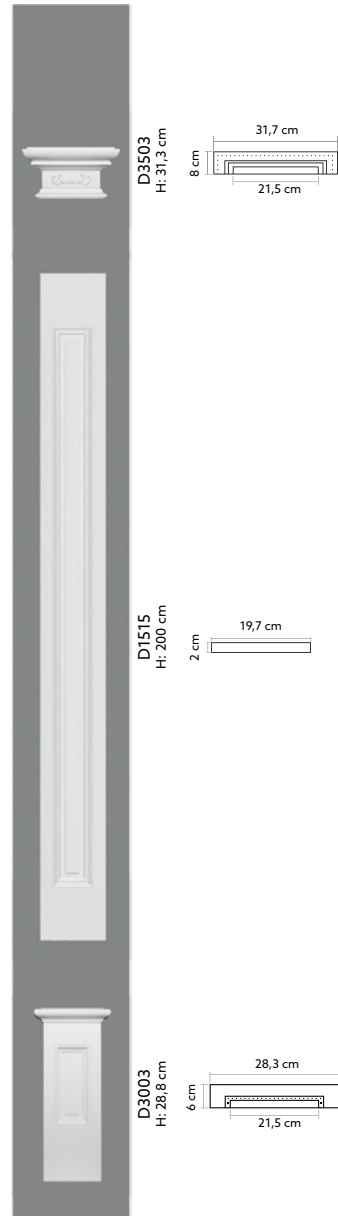

D3503  
H: 31,3 cm

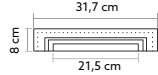

D1515  
H: 200 cm

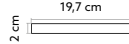

D3003  
H: 28,8 cm

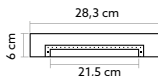

ProFoam®

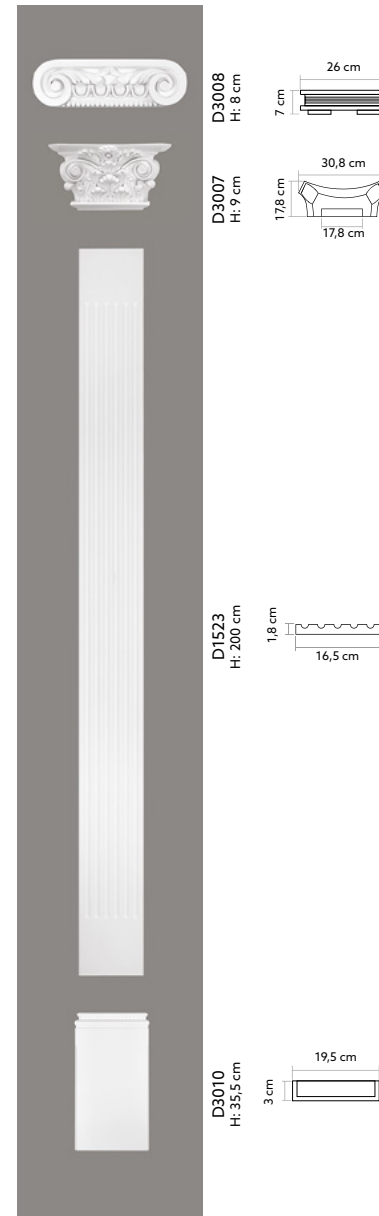

D3008  
H: 8 cm

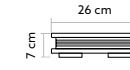

D3007  
H: 9 cm

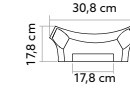

D1523  
H: 200 cm



D3010  
H: 35,5 cm

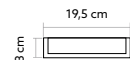

ProFoam®

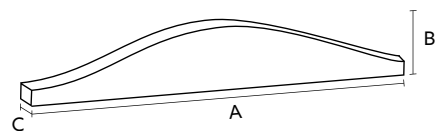

A x B x C (cm)



**D2531**  
124/110 x 25 x 8,8/2,3 cm  
ProFoam®



**D2512**  
125 x 19,5 x 3 cm  
ProFoam®

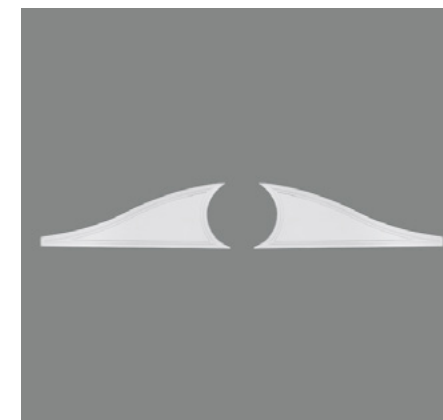

**D3515**  
31,5 x 11 x 0,6 cm  
ProFoam®



**D3517**  
32 x 13 x 1,5 cm  
ProFoam®



**C8031**  
15,6 x 24,2 x 12 cm  
ProFoam®



**C8035**  
10,5 x 14 x 5,5 cm  
ProFoam®



ProFoam®

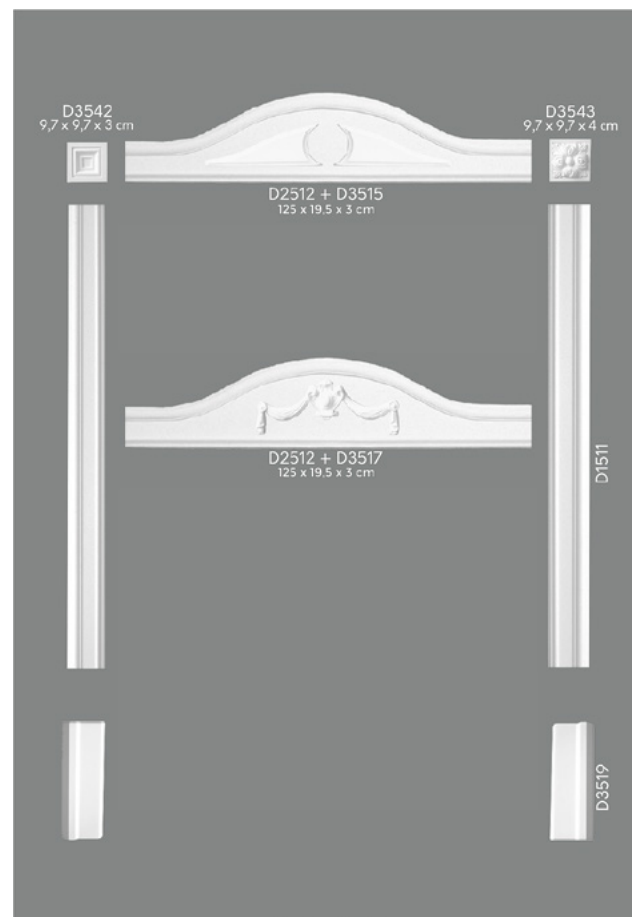

ProFoam®



1. MD356    2. MD325



MD359E

240 x 7 x 1,6 cm

PolyForce® | ScratchShield®

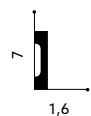

MD008E

240 x 8 x 1,7 cm

PolyForce® | ScratchShield®

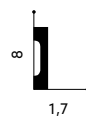

MD258E

240 x 8,1 x 1 cm

PolyForce® | ScratchShield®

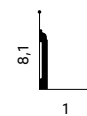

MD094E

240 x 9,4 x 1,2 cm

PolyForce® | ScratchShield®







**MD009E**  
240 x 10 x 1,7 cm  
PolyForce® | ScratchShield®



**MD356E**  
240 x 11 x 1,5 cm  
PolyForce® | ScratchShield®





# Aksesoria

Accessories | Zubehör | D'accessoires

## pl

**Aby maksymalnie uprościć montaż produktów, stworzyliśmy gamę akcesoriów, dzięki którym proces instalacji będzie szybki, łatwy i skuteczny.**

## de

Für unsere Produkte bieten wir eine Vielzahl von hilfreichen Zubehör an, welches die Montage einfach, schnell und effizient ermöglicht.

## en

To simplify the assembly of products as much as possible, we have created a range of accessories that will make the installation process quick, easy and effective.

## fr

Afin de faciliter le montage de nos produits, nous avons créé une gamme d'accessoires pour rendre le processus d'installation rapide, facile et efficace.



NEW



330 g

## MASA SZPACHLOWA MARDOM DECOR

MARDOM DECOR FLEX FILLER  
MARDOM DECOR SPACHTELMASSE  
MASTIC FLEXIBLE MARDOM DECOR

**pl**

**Elastyczna masa szpachlowa idealna do łączenia sztukaterii. Do stosowania wewnątrz pomieszczeń na twardych, suchych, czystych i przyczepnych powierzchniach. Do wypełniania ubytków, pęknięć i szweli o głębokości do 5 mm. Można nakładać na: gips, płyty gipsowe, kafle gipsowe, beton, beton komórkowy, cement, cegłę, kamień, starą malowaną powierzchnię. Produkt gotowy do użycia.**

- Odporna na wilgoć
- Łatwe nakładanie i szlifowanie
- Zapobiega powstawaniu pęknięć

**de**

Eine elastische Spachtelmasse, ideal zum Ausbessern und füllen von Stuck. Zu verwenden in Innenräumen auf festen, trockenen, sauberen und haftenden Oberflächen. Zum Auffüllen von Vertiefungen, Rissen und Fehlstellen bis zu einer Tiefe von 5 mm. Anwendbar auf allen unseren Produkten, Gips, Gipsplatten, Gipsfliesen, Beton, Porenbeton, Schaumbeton, Zellbeton, Zement, Ziegelstein, Stein und gestrichene Oberflächen. Das Produkt ist sofort gebrauchsfertig.

- Feuchtigkeitsbeständig
- Leichtes auftragen und schleifen
- Beugt Rissbildungen vor

**en**

Flex filler - ideal for jointing mouldings. For indoor use on hard, dry, clean and adhesive surfaces. To fill cavities, cracks and fissures up to 5 mm deep. It can be applied on: plaster, plaster boards, plaster tiles, concrete, autoclaved aerated concrete, cement, brick, stone, old paint. Ready to use.

- Resistant to moisture
- Easy to apply and sand
- Prevents cracks from forming

**fr**

Mastic flexible, idéal pour assembler les cimaises. Pour une utilisation en intérieur sur des surfaces dures, sèches, propres et adhésives. Pour le remplissage de cavités, fissures et interstices jusqu'à 5 mm de profondeur. Peut être appliqué sur: du plâtre, plaques de plâtre, carreaux de plâtre, béton, béton cellulaire, ciment, brique, pierre, ancienne surface peinte. Le produit est prêt à l'emploi.

- résistant à l'humidité
- facile à appliquer et à poncer
- empêche la formation de fissures



290 ml



300 ml

## MARDOM MAX PolyForce® | ProFoam®

### pl

**Klej montażowy, hybrydowy, polimerowy, o maksymalnej sile wiązania wewnątrz i na zewnątrz pomieszczeń, na powierzchniach porowatych i gładkich. Błyskawiczna szybkość chwytu – już po 8 sekundach. Jedno opakowanie kleju wystarcza na przyklejenie średnio 8 metrów listwy. Kolor biały.**

### de

Der Hybridkleber - mit maximaler Anfangshaftung - ist sowohl im Innen- und Außenbereich und auch auf rauen und glatten Oberflächeneinsetzbar. Es tritt eine sofortige Haftung in nur 8 Sekunden ein. Farbe Weiß.

## MARDOM FIX PRO PolyForce® | ProFoam®

### pl

**Klej montażowy na bazie wody, do stosowania wewnątrz pomieszczeń. Służy do klejenia listwy do ściany lub sufitu. Charakteryzuje się trwałym i mocnym wiązaniem. Może być stosowany na powierzchniach porowatych. Jedno opakowanie kleju wystarcza na przyklejenie średnio 8 metrów listwy. Kolor biały.**

### de

Ein Montagekleber der für den Innenbereich entwickelt wurde. Es zeichnet sich durch eine dauerhafte und starke Haftung aus, ist schnell trocknend und geruchlos. Das Produkt enthält keine Lösungsmittel. Es kann auf verschiedenen Untergründen (z.B. Mineralputz, Gipskartonplatten, Holz, Beton, etc.) eingesetzt werden.

### en

Hybrid, polymer, installation adhesive with extreme bonding strength indoors and outdoors, on rough and smooth surfaces. Immediate bonding after 8 seconds. One package is enough for installation about 8 meters of the mouldings. White colour.

### fr

Colle de montage, hybride, polymère, avec une force d'adhérence maximale pour une utilisation intérieur et l'extérieur, sur des surfaces poreuses et lisses (carreaux, verre). Vitesse d'adhésion ultra-rapide - après seulement 8 secondes. Un tube de colle suffit pour coller 8 mètres de moulure en moyenne. Couleur blanche.

### en

Water-based, installation adhesive for interior applications on porous surfaces. The adhesive provides long-lasting seal between mouldings and the surface (wall and ceiling). One package is enough for installation about 8 meters of the mouldings. White color.

### fr

Adhésif d'assemblage à base d'eau pour une utilisation en intérieur. Il est utilisé pour coller la moulure au mur ou au plafond. Il se caractérise par une liaison durable et forte. Peut être utilisé sur des surfaces poreuses. Un paquet d'adhésif suffit pour coller en moyenne 8 mètres de moulure. Blanc. Capacité : 300 ml



## MARDOM FIX EXTRA ProFoam®

### pl

**Klej na bazie poliuretanu, do spoinowania i łączenia listew między sobą. Do stosowania wewnątrz i na zewnątrz pomieszczeń. Jedno opakowanie kleju wystarcza na połączenie średnio 80 metrów listew. Klej przezroczysty.**

### de

Der Kleber ist für die Stoßkantenverklebung der Mardom Decor Stuckelemente bestimmt. Das Produkt enthält keine Lösungsmittel. Der Klebstoff sorgt für eine starke und dauerhafte Verbindung. Es kann auf verschiedenen Untergründen (z.B. Mineralputz, Gipskartonplatten, Holz, Beton, etc.) eingesetzt werden.

### en

An adhesive designed for bonding and grouting of Mardom Decor mouldings. In addition to its adhesive properties, it also seals the bonds between the elements. The product does not contain solvents. The adhesive provides strong and solid bonding. It can be applied on various surfaces (i.a. mineral plasters, plasterboard panels, wood, concrete, etc.).

### fr

Adhésif à base de polyuréthane, pour jointer et assembler les moulures entre elles. Pour un usage intérieur et extérieur. Un tube de colle suffit pour jointer en moyenne 80 mètres de moulures. Colle transparente.



## LAKIER SATYNOWY DO MASKOWANIA ŁĄCZEŃ

SATIN VARNISH FOR MASKING JOINTS | SATINLACK | VERNIS SATIN POUR MASQUER LES JOINTS

### pl

**Satynowy lakier służy do maskowania łączy listew przypodłogowych Mardom Decor Premium, które są pokryte ekskluzywną satynową powłoką.**

### de

Der Satinlack wird zum Abdecken von Mardom Decor Premium Sockelleisten verwendet, die mit einer exklusiven Satinbeschichtung versehen sind.

### en

Satin varnish is used for masking Mardom Decor Premium skirting boards, which are covered with an exclusive satin coating.

### fr

Le vernis satiné est utilisé pour masquer les jointures des moulures Mardom Decor Premium, qui sont recouvertes d'un revêtement satiné exclusif.



## SKRZYŃKA UCIOSOWA

MITER BOX | MITER BOX | LA BOITE A ONGLETS

**pl**

**Skrzynka uciosowa Mardom Decor do przycinania listew pod kątem 45 lub 90 stopni. Wykonana z wysokogatunkowego materiału.**

**de**

Die Mardom Decor Gehrungslade zum Schneiden von Leisten in einem Winkel von 45° oder 90°. Sie ist aus hochwertigem Material hergestellt.

**en**

Mardom Decor miter box for cutting mouldings at an angle of 45° or 90°. Made of highgrade material.

**fr**

Boîte à onglets Mardom Decor pour couper les moulures à 45 ou 90 degrés. Fabriqué à partir de matériau de haute qualité.



## TAŚMA ALUMINIOWA

ALUMINIUM TAPE | ALUMINIUMBAND | RUBAN ALUMINIUM

**pl**

**Taśma aluminiowa służy do montażu listew oświetleniowych. Szerokość 5 cm. Długość: 45 m.**

**de**

Das Aluminium-Klebeband wird zur Befestigung von Lichtbändern verwendet. Breite 5 cm. Länge: 45 m.

**en**

Aluminium tape, used for the installation of lighting mouldings. Width: 5 cm. Length: 45 m.

**fr**

Le ruban en aluminium est utilisé pour l'assemblages les corniches lumineuses. Largeur 5 cm. Longueur: 45 m.



## SŁUPEK EKSPOZYCYJNY

TOWER DISPLAY | MUSTER TOWER | TOUR D'EXPOSITION

224 x 59,5 cm

**pl**

**Tekturowy słupek to ekspozytor, dzięki któremu na niewielkiej powierzchni zaprezentujesz wszystkie listwy.**

**de**

Der Muster Tower ist ein Ausstellungsstück, dank dem Sie alle Leisten auf einer kleinen Fläche präsentieren können.

**en**

The cardboard tower is a display that allows you to present all the mouldings on a small area.

**fr**

La tour en carton est un présentoir qui permet de proposer toutes les moulures sur une petite surface.



## TABLICA „ELITE”

„ELITE” BOARD | „ELITE”-ANZEIGETAFEL | PRESENTOIT „ELITE”

150 x 66 cm

**pl**

**Prezentuje wszystkie listwy przypodłogowe.**

**de**

Die „Elite”-Anzeigetafel präsentiert alle Sockelleisten.

**en**

The board presents all skirting boards.

**fr**

Il présente toutes les plinthes.



## TABLICA „PREMIUM”

„PREMIUM” BOARD | „PREMIUM”-ANZEIGETAFEL | PRESENTOIR „PREMIUM”

133 x 45 cm

**pl**

**Prezentuje wybrane listwy przypodłogowe pokryte satynową powłoką SupremeSatin®. Występuje w komplecie ze sztalugą.**

**de**

Die „Premium“-Anzeigetafel präsentiert ausgewählte Sockelleisten mit der Satinierung SupremeSatin®-Beschichtung. Es wird komplett mit einer Staffelei geliefert.

**en**

The board presents selected skirting boards covered with SupremeSatin® coating. It comes complete with an easel.

**fr**

Il propose une sélection de moulures recouvertes d’un revêtement satiné SupremeSatin®. Il est livré avec un chevalet.

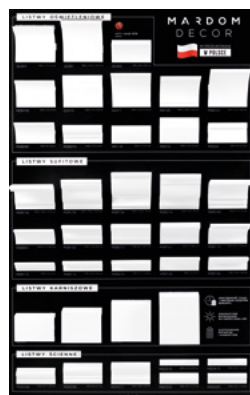

## TABLICA „PRESTIGE”

„PRESTIGE” BOARD | „PRESTIGE”-ANZEIGETAFEL | PRESENTOIR „PRESTIGE”

150 x 94 cm

**pl**

**Prezentuje wybrane listwy ścienne, sufitowe, karniszowe i oświetleniowe.**

**de**

Die „Prestige“-Anzeigetafel präsentiert ausgewählte Wand-, Decken-, Vorhangschienen und Beleuchtungsleisten.

**en**

The board presents selected panel mouldings, cornice mouldings, curtain profiles and lighting mouldings.

**fr**

Il propose une sélection de moulures, de corniches de plafonds, cache tringles à rideaux et d’éclairage.





## TABLICA „BESTSELLERY”

„BESTSELLERS” BOARD | „BESTSELLERY”-ANZEIGETAFEL | PRESENTOIR „BESTSELLERS”

150 x 50 cm

**pl**

Prezentuje listwy najczęściej wybierane przez klientów.

**de**

Die „Bestsellery“-Anzeigetafel präsentiert die Leisten, die am häufigsten von Kunden gewählt werden.

**en**

The board presents the mouldings that are the top-choice of the customers.

**fr**

Il propose les moulures les plus souvent choisies par les clients.



## WALIZKI ALUMINIOWE

ALUMINIUM SUITCASES | DIE ALUMINIUMKOFFER | VALISES EN ALUMINIUM

**pl**

Przenośne narzędzie, idealne dla architektów. Mała walizka zawiera listwy podłogowe. Duża walizka zawiera wybrane listwy ścienne, sufitowe, karniszowe i oświetleniowe.

Duża walizka: 49 x 64 x 17,5 cm

Mała walizka: 41,5 x 56,5 x 16,5 cm

**de**

Die Aluminiumkoffer eignen sich ideal für Bauprojekte und Architekten. Der kleine Koffer enthält hierbei Sockelleisten. Der große Koffer enthält ausgewählte Wand-, Decken-, Gardinen- sowie LED taugliche Lichtleisten.

Große Koffer: 49 x 64 x 17,5 cm

Kleine Koffer: 41,5 x 56,5 x 16,5 cm

**en**

A portable tool, ideal for architects. The small suitcase contains skirting boards. The large suitcase contains selected wall mouldings, cornice mouldings, curtain profiles and lighting mouldings.

Big suitcase: 49 x 64 x 17,5 cm

Small suitcase: 41,5 x 56,5 x 16,5 cm

**fr**

Un outil portable, parfait pour les architectes. La petite valise contient des plinthes. La grande valise contient une sélection de moulures, corniches de plafond, cache tringles à rideaux et d'éclairage.

Grande valise: 41,5 x 56,5 x 16,5 cm

Petite valise: 29,5 x 41,5 x 13,5 cm



## PUDEŁKO Z PRÓBKAMI

SAMPLE BOX | MUSTERBOX | BOÎTE D'ÉCHANTILLONS

### pl

**Tekturowe pudełko z próbkami Mardom Decor to doskonały sposób, żeby zapoznać się z najpopularniejszymi wzorami listew. Pudełko jest lekkie i kompaktowe, dzięki czemu może być przydatnym narzędziem dla architektów.**

### de

Die Mardom Decor-Musterbox ist die perfekte Möglichkeit, um sich mit den beliebtesten Profilen vertraut zu machen. Die Box ist leicht und kompakt, was sie zu einem nützlichen Werkzeug für Architekten macht.

### en

A cardboard box with Mardom Decor samples is a great way to see the most popular patterns of the mouldings. The box is light and compact, making it a useful tool for architects.

### fr

La boîte en carton contenant des échantillons Mardom Decor est une solution parfaite pour découvrir les modèles les plus populaires des plinthes. La boîte et légère est petite, elle peut s'avérer un outil particulièrement utile pour les architectes.



## KUFEREK LAMELLI

LAMELLA BOX | MUSTERKOFFER MIT LAMELLEN | COFFRET DE LAMELLES

### pl

**Wygodne i funkcjonalne narzędzie do prezentowania lameli oraz zakończeń Lamelli. Kuferek zawiera próbki wszystkich dostępnych dekorów. Próbki mogą być łatwo wyjmowane z walizki, dzięki czemu klient może przyłożyć je do ściany, czy mebli. Kuferek wyposażony jest w rączkę i praktyczne napy, dlatego jest wygodny w przenoszeniu i transporcie.**

**Wysokość: 21,5 cm | Głębokość: 28 cm | Szerokość: 46,5 cm**

### de

Ein praktisches und funktionelles Tool für die Präsentation von Lamellen und ihrer Endstücke. Der Koffer enthält Muster aller verfügbaren Dekore. Die Muster lassen sich leicht aus dem Koffer nehmen, so dass der Kunde sie an die Wand oder Möbel zum Vergleich legen kann. Der Koffer ist mit einem Griff und praktischen Verschlüssen ausgestattet, so dass er bequem zu tragen und zu transportieren ist.

Höhe: 21,5 cm | Tiefe: 28 cm | Breite: 46,5 cm

### en

A convenient and functional tool for presenting lamellas and lamella endings. The box contains samples of all available decors. The samples can be easily removed from the suitcase, so that the customer can put them against the wall or furniture. The box is fitted with a handle and practical press studs, which makes it convenient to carry and transport.

Height: 21.5 cm | Depth: 28 cm | Width: 46.5 cm

### fr

Outil très pratique et confortable pour la présentation des lamelles et de leurs embouts. Le coffret contient les échantillons de tous les modèles disponibles. Vous pouvez facilement sortir les échantillons du coffret afin que le client puisse les appliquer sur le mur ou le meuble. Le coffret dispose d'une poignée et de fermetures pratiques, il est donc facile à transporter et déplacer.

Hauteur : 21,5 cm | Profondeur : 28 cm | Largeur : 46,5 cm



## WZORNIK KSIĄŻKOWY LAMELLI

LAMELLA SAMPLE BOOK | MUSTERBUCH MIT LAMELLEN | LIVRE CATALOGUE DE LAMELLES

### pl

**Funkcjonalny próbnik prezentujący wszystkie dostępne dekory lameli, zakończenia oraz dedykowaną listwę przypodłogową. Wewnątrz znajdują się wymiary techniczne i parametry, co może być przydatną pomocą dla sprzedawców. Próbkki są na stałe przytwierdzone do wzornika, dzięki czemu książka nie zostanie zdekompletowana.**

**Wysokość: 70 cm | Głębokość: 8,5 cm**

**Szerokość złożonego wzornika: 36 cm**

**Szerokość rozłożonego wzornika: 119,5 cm**

### de

Ein funktionelles Warenmuster mit allen verfügbaren Lamellendekoren, Endstücken und speziellen Sockelleisten. Im Buch finden Sie technische Maße und Parameter, die für Händler eine nützliche Hilfe sein können. Die Warenmuster sind fest mit dem Musterbuch verbunden, so dass die Buchkarten nicht getrennt werden können.

Höhe: 70 cm | Tiefe: 8,5 cm

Breite des gefalteten Warenmusters: 36 cm

Breite des aufgeklappten Warenmusters: 119,5 cm

### en

A functional sampler presenting all available lamella decors, endings and a dedicated skirting board. It contains technical dimensions and parameters, which can be a useful help for sellers. The samples are permanently attached to the book, thanks to which the book cannot be rendered incomplete.

Height: 70 cm | Depth: 8.5 cm

Width of the folded sample book: 36 cm

Width of the unfolded sample book: 119.5 cm

### fr

Un catalogue d'échantillons fonctionnel qui présente tous les modèles de lamelles, les emboutset les plinthes correspondantes. Vous trouverez à l'intérieur toutes les dimensions et paramètres techniques, ce qui peut être très utile pour les commerciaux. Les échantillons sont solidement fixés au livre catalogue, il n'existe donc aucun risque de détachement des éléments.

Hauteur : 70 cm | Profondeur : 8,5 cm

Largeur du catalogue fermé : 36 cm

Largeur du catalogue ouvert : 119,5 cm



## EKSPOZYTOR PREMIUM LAMELLI

PREMIUM LAMELLA DISPLAY | PREMIUM LAMELLEN-DISPLAY | PRÉSENTOIR HAUT DE GAMME DES LAMELLES

### pl

**Ekscyzywny ekspozytor w formie stojącego standu. Zawiera wkłady prezentujące na większej powierzchni wszystkie dostępne dekory. Wkłady mogą być łatwo wyjmowane ze stojaka i przykładane do innych elementów wnętrza np. mebli czy ścian. Ekspozytor posiada podświetlany logotyp oraz boki, co nadaje mu ekskluzywnego wyglądu.**

**Wysokość: 185 cm | Głębokość: 131 cm | Szerokość: 65 cm**

**Wymiar wkładu: 57,5 x 100 cm**

### de

Ein exklusives Display in Form eines Ständers. Enthält Einsätze, die alle verfügbaren Dekore auf einer größeren Fläche präsentieren. Die Einsätze lassen sich leicht vom Ständer abnehmen und an andere Innenelemente wie Möbel oder Wände zum Vergleich legen. Das Display hat ein beleuchtetes Logo und beleuchtete Seiten für einen exklusiven Look.

Höhe: 185 cm | Tiefe: 131 cm | Breite: 65 cm

Abmessungen des Einsatzes: 57,5 x 100 cm

### en

An exclusive display in the form of a standing rack. Contains inserts presenting all available decors on a larger surface. Inserts can be easily removed from the rack and applied to other elements of the interior, e.g. furniture or walls. The display has an illuminated logo and sides, which gives it an exclusive look.

Height: 185 cm | Depth: 131 cm | Width: 65 cm

Insert size: 57.5 x 100 cm

### fr

Présentoir haut de gamme à poser verticalement. Il comporte tous les modèles disponibles présentés sur une plus grande surface. Les modèles échantillons peuvent être facilement retirés du présentoir et comparés à d'autres éléments de l'intérieur comme p.ex. les meubles ou les murs. Le logo apposé et les côtés du présentoir sont rétro-éclairés, ce qui assure son caractère haut de gamme.

Hauteur : 185 cm | Profondeur : 131 cm | Largeur : 65 cm

Dimensions des modèles échantillons : 57,5 x 100 cm



1. MD358

2. MD325

2. MD003



- pl**
1. Listwy powinny być aklimatyzowane przez około 48 godzin w pomieszczeniu, w którym będą montowane.
  2. Przykładamy listwę do rogu sufitu i ściany w pozycji montażowej.

- en**
1. The mouldings should be acclimated for approximately 48 hours in the room in which they are installed.
  2. Place the moulding in the corner of the ceiling and wall in the desired installation position.

- de**
1. Die Leisten sollten zur Aklimatisierung 48 Stunden bei Raumtemperatur gelagert werden.
  2. Die Leiste an der Wand-/Deckenfläche in die gewünschte Position bringen. Die zweite Leiste dagegensetzen.

- fr**
1. Les plinthes doivent être acclimatées pendant environ 48 heures dans la pièce de destination.
  2. Placez la moulure dans l'angle du plafond et du mur dans la position d'installation souhaitée.

- pl**
3. Obrysowujemy dolną i górną krawędź wzdłuż listwy aż do przeciwległej ściany, na której będziemy montowali drugą listwę.
  4. Analogicznie postępujemy na drugiej prostopadłej ścianie.

- en**
3. Outline the top and bottom edge along the moulding all the way to the opposite wall, where the next moulding will be installed.
  4. Repeat the same actions on the perpendicular wall.

- de**
3. Markieren Sie nun die entlang der zweiten Leiste mit einem Bleistift die Schnittfläche.
  4. Das wiederholen Sie verkehrt herum nun auch mit der zweiten Leiste.

- fr**
3. Tracez le contour du bord supérieur et inférieur le long de la moulure jusqu'au mur opposé, où la moulure suivante sera installée.
  4. Répétez les mêmes actions sur le mur perpendiculaire.

- pl**
5. Uzyskujemy w ten sposób obrys i linie (kąty) montażu i cięcia listew względem siebie. Dolny punkt linii cięcia listwy znajduje się w samym narożniku tj. w punkcie łączenia dwóch ścian. Górny punkt linii cięcia listwa znajduje się na narysowanym w pkt 3 przecięciu linii krawędzi górnej listew (na suficie) pod kątem 90 stopni.

- en**
5. In this way we obtain an outline and the lines (angles) for the installation and cutting of the mouldings in relation to each other. The lower point of the moulding cutting line is located in the corner, that is, at the point where the two walls join. The upper point of the moulding cutting line is located at the point (drawn in point 3) where the lines of the upper edges of the mouldings (on the ceiling) intersect at an angle of 90 degrees.

- de**
5. Auf diese Weise haben Sie die genauen Schnittpunkte, welche mit einer Gehrungssäge oder auch Kappsäge passgenau geschnitten werden können. Der Winkel beträgt 90 Grad.

- fr**
5. De cette façon, nous obtenons un contour et les lignes (angles) pour l'installation et la découpe des moulures les unes par rapport aux autres. Le point inférieur de la ligne de coupe du moulage est situé dans le coin, c'est-à-dire au point de jonction des deux murs. Le point supérieur de la ligne de coupe des moulures est situé au point (dessiné au point 3) où les lignes des bords supérieurs des moulures (au plafond) se croisent à un angle de 90 degrés.



**pl** 6. Cięcia dokonujemy na ukośnicy lub na odpowiednio dużym w stosunku do wysokości listwy korycie uciosowym.

**en** 6. The cutting is performed on a mitre or a mitre box sufficiently large in relation to the height of the moulding.

**de** 6. Achten Sie bitte auf eine ausreichend große Gehrungslade, in welche die Profile hineinpassen.

**fr** 6. La découpe est effectuée à l'aide d'une boîte à onglets suffisamment grande par rapport à la hauteur de la moulure.



**pl** 7. Klej Fix Pro nakładamy po długości na lewej stronie profilu w miejscu styku z klejonym podłożem.

8. Klej nakładamy faliście (ewentualnie liniowo w przypadku niewielkich listew o małej powierzchni klejenia).

**en** 7. The Fix Pro adhesive is applied along the length on the left side of the profile in the point of contact with the glued surface.

8. The adhesive is applied in sinuous lines (or in straight lines in the case of small mouldings with small bonding area).

**de** 7. Nun den Mardom Fix Pro Kleber auf die vorgesehenen Klebeflächen auftragen.

8. Der Kleber sollte wellenförmig aufgetragen werden. Bei kleinen Leisten mit geringer Klebefläche auch linear.

**fr** 7. Appliquez l'adhésif Fix Pro sur la longueur côté gauche du profil au point de contact avec la surface de destination.

8. La colle est appliquée en vague (ou en ligne droite dans le cas de petites moulures avec une petite zone de collage).



**pl** 9. Listwę mocno dociskamy do podłoża. Zbieramy nadmiar wyciśniętego kleju.

**en** 9. Firmly press the moulding against the surface. Remove the excess glue that was squeezed out.

**de** 9. Nun die Leiste fest an die endgültige Position drücken und den überschüssigen Kleber mit einem Spachtel entfernen.

**fr** 9. Appliquez fermement la moulure contre le mur. Retirez l'excès de colle qui a été pressé.





**pl** 10. Postępujemy analogicznie w przypadku drugiej ściany. Przykładamy i doklejamy drugi profil, odpowiednio docięty do łączonej listwy.

**en** 10. Repeat the same actions on the second wall. Place and glue the second profile, properly cut to match the joined moulding.

**de** 10. Diesen Vorgang wiederholen Sie mit der 2. Leiste, wobei darauf zu achten ist, das Sie für die Stoßverbindung der beiden Leisten den Mardom Fix Extra Kleber verwenden.

**fr** 10. Procédez de la même pour le deuxième mur. Appliquez et collez le deuxième profil, coupé de manière appropriée pour correspondre à la moulure jointe.



**pl** 11. Łączenie dwóch listew wypełniamy klejem Fix Extra, dociskając następnie do siebie obie listwy. Nadmiar kleju zbieramy. Po 1-2 godzinach należy skontrolować i ewentualnie zebrać nadmiar kleju Fix Extra (ponieważ potrafi w wyniku reakcji z ProFoam® wypłynąć na wierzch).

**en** 11. Fill the joint between the two mouldings with Fix Extra adhesive and press both mouldings together. Collect the excess adhesive. After 1-2 hours it is necessary to check and possibly collect excess Fix Extra adhesive (as it can may come out on the surface due to a reaction with ProFoam®).

**de** 11. Nach dem zusammen drücken der Leisten entfernen Sie den überschüssigen Fix Extra Kleber sorgfältig mit einem scharfen Spachtel. In der Aushärtung quillt der Kleber leicht nach, so dass Sie nach 1 bis 2 Stunden den überschüssigen Kleber erneut abziehen sollten. Nach endgültiger Aushärtung ist dieser nicht schleifbar!

**fr** 11. Remplissez la jonction deux moulures avec de la colle Fix Extra, en pressant les deux moulures l'une contre l'autre. Retirez l'excès de colle. Après 1 à 2 heures, vérifiez et, si nécessaire, retirez l'excédent d'adhésif Fix Extra (car il peut sortir à la surface en raison d'une réaction avec ProFoam®).



**pl** 12. Szczelinę pomiędzy ścianą\sufitem a listwą, oraz pomiędzy dwoma listwami, obrabiamy przy pomocy kleju Fix Pro .Zbieramy nadmiar kleju. Po stwardnieniu klej Fix Pro można szlifować

**en** 12. Fill the gap between the wall\ceiling and the moulding, and the gap between the two mouldings with Fix Pro adhesive. Collect the excess adhesive. The Fix Pro adhesive can be grinded once it is cured.

**de** 12. Zum Abschluss sämtliche noch bestehenden Fugen mit dem Mardom Fix Pro ausspritzen. Dieser kann nach der Trocknung mit allen handelsüblichen Anstrichmitteln gestrichen werden.

**fr** 12. Remplissez l'espace entre le mur / plafond et la moulure, ainsi que l'espace entre les deux moulures avec l'adhésif Fix Pro. Récupérez l'excès d'adhésif. L'adhésif Fix Pro peut être poncé une fois durci.



**pl**  
— **13. Do końcowego maskowania i wygładzania łączeń można użyć szpachli.**

**en**  
— 13. A putty knife can be used for the final masking and smoothing of the joints.

**de**  
— 13. Zur Verdichtung zwischen Leiste und Decke, bzw. Wandfläche nehmen Sie bitte auch den Mardom Fix Pro Kleber.

**fr**  
— 13. Le mastic peut être utilisé pour le masquage final et le lissage des joints.



**pl**  
— **Odwiedź nas na kanale MARDOM DECOR na youtube.com**

**en**  
— Visit the MARDOM DECOR channel on youtube.com

**de**  
— Eine anschauliche Anleitung der Verarbeitung finden Sie auch auf unserem YouTube Kanal unter Mardom Decor.

**fr**  
— Visitez-nous sur la chaîne Mardom Decor sur YouTube.

**pl**

**Produkty Mardom Decor mogą być montowane na zewnątrz budynków i w pomieszczeniach o podwyższonej wilgotności. Konieczne jest wówczas zastosowanie kleju Mardom Fix Extra. Przy montażu na zewnątrz, produkty muszą zostać pokryte farbą zewnętrzną. Aby zapobiec problemom z montażem, produkty należy aklimatyzować przez 24-48 godzin w pomieszczeniu, w którym będą montowane. Zalecamy sprawdzenie wymiarów produktów przed montażem, ponieważ wartości podane w katalogu mogą nieznacznie odbiegać od rzeczywistości.**

**GWARANCJA**

**Na produkty Mardom Decor obowiązuje 12 miesięcy gwarancji pod warunkiem zastosowania klejów sugerowanych przez firmę Mardom Sp. z o.o. oraz spełnienia wszystkich warunków dotyczących instrukcji montażu. Gwarancja nie uwzględnia wad i uszkodzeń spowodowanych niewłaściwym przygotowaniem do instalacji, użytkowaniem lub montażem.**

\*\*\*

**Wszelkie parametry techniczne oraz atesty na tworzywa PolyForce® oraz ProFoam® dostępne są na stronie [www.mardomdecor.com](http://www.mardomdecor.com).**

**en**

Mardom Decor products can be installed outdoors and in rooms with high humidity. It is necessary to use Mardom Fix Extra adhesive then. When you install the mouldings outdoors, the products must be covered with exterior paint. We recommend checking the product dimensions prior to installation, because the values given in the catalog may slightly differ from actual measurements. In order to prevent issues with installation, products should be acclimated for 24-48 hours in the room in which they will be installed.

**GUARANTEE**

Mardom Decor products are covered by a 12 month warranty, provided that the customer uses the adhesives suggested by Mardom Sp. z o.o. and all the conditions relating to the installation instructions are met. The warranty does not cover defects and damage resulting from improper preparation for installation, improper use or improper installation.

\*\*\*

All the technical parameters and certificates for the PolyForce® and ProFoam® materials are available on the [www.mardomdecor.com](http://www.mardomdecor.com) website.

**de**

Die Produkte von Mardom Decor können im Außenbereich und in Räumen mit erhöhter Luftfeuchtigkeit angebracht werden. Die Verwendung von Mardom Fix Extra Kleber ist hierfür erforderlich. Bei der Verwendung im Außenbereich müssen die Produkte mit einer Außenlackierung versehen werden. Wir empfehlen, die Abmessungen der Produkte vor der Installation zu überprüfen, da die im Katalog angegebenen Werte geringfügig abweichen können. Um Probleme bei der Installation zu vermeiden, müssen die Produkte für 24-48 Stunden in einem Raum offen lagern, bevor sie verbaut werden.

**GARANTIE**

Für Mardom Decor-Produkte ist eine 12-Monate-Garantie vorausgesetzt, sofern die von der Firma Mardom Sp. z o.o. vorgeschlagen Klebstoffe verwendet und alle Bedingungen für Installationsanweisungen erfüllt werden. Die Garantie umfasst nicht Mängel und Schäden, die durch unsachgemäße Vorbereitung für die Installation, Verwendung oder Montage verursacht werden.

\*\*\*

Alle technischen Spezifikationen und Freigaben von ProFoam®- PolyForce®-Kunststoffen sind auf der Seite [www.mardomdecor.com](http://www.mardomdecor.com) verfügbar.

**fr**

Les produits Mardom Decor peuvent être installés en extérieur et dans des pièces humides. Il est alors nécessaire d'utiliser la colle Mardom Fix Extra. Pour une installation extérieure, les produits doivent être recouverts d'une peinture adaptée. Nous vous recommandons de vérifier les dimensions des produits avant le montage, car les valeurs données dans le catalogue peuvent légèrement varier. Pour éviter les problèmes d'installation, stockez les produits à température ambiante pendant 24 à 48 heures dans la pièce de destination.

**GARANTIE**

Les produits Mardom Decor bénéficient d'une garantie de 12 mois à condition que les adhésifs recommandés par Mardom Sp. z o.o. soient utilisés et que toutes les conditions des notices de montage soient remplies. La garantie ne couvre pas les défauts ou les dommages causés par une préparation inadéquate de l'installation, par une utilisation ou un montage non conformes.

\*\*\*

Tous les paramètres techniques et les homologations de PolyForce® et ProFoam® sont disponibles sur [www.mardomdecor.com](http://www.mardomdecor.com).

<b>B</b>		C4002H	99, 101	<b>L</b>		MD025	22, 29, 38, 44, 48
—		C4002W	95, 97	—		MD026	26
B2002	92	C5000-4H	98, 100	L0101	54, 56	MD027	19
B2003	92	C5000-4W	94, 96	L0102	53, 54, 57	MD028	19
B2021	92	C5001-4H	99, 100, 101	L0103	53, 54, 58	MD070	36, 46
B3002	90	C5001-4W	95, 96, 97	L0104	53, 54, 59	MD094	21, 93
B3014	90	C5002-4H	99, 101	L0105	50, 53, 54, 60	MD094E	112
B3015	92	C5002-4W	95, 97	L0106	53, 54, 61	MD095	18, 23
B3020	91	C8031	109	L0201	62, 64	MD105	16, 38, 48
B3021	90	C8035	109	L0202	62, 65	MD106	35, 45
B3023	91			L0203	62, 66	MD110	16, 37, 47
B3025	78, 86, 91	<b>D</b>		L0204	62, 67	MD111	16, 37, 47
B3029	90	—		L0205	62, 68	MD118	35, 46
B3030	90	D1500	105	L0206	62, 69	MD137	16, 37, 47
B3033	90	D1504	105, 108, 110	L0301	70, 72	MD145	35, 46
B3038	91	D1511	105, 107, 111	L0302	70, 73	MD156	17, 38, 48
B3047	91	D1515	106, 108	L0303	70, 74	MD161	16, 37, 47
B3050	92	D1516	106, 107	L0304	70, 75	MD172	33, 45
B3077	92	D1518	106, 107	L0305	70, 76	MD210	34, 45
B3110	90	D1523	106, 108	L0306	70, 77	MD213	16, 36, 46
		D1541	105, 107			MD234	20
<b>C</b>		D2512	109, 110	<b>MD</b>		MD235	19
—		D2531	109, 110	—		MD236	21
C1000-1H	98, 100	D3003	104, 107, 108	MD001	19	MD237	29
C1000-1W	94, 96	D3007	103, 108	MD002	4, 24, 26, 50, 89	MD255	25
C1000-2H	98, 100	D3008	102, 108	MD002-10	87	MD258	20
C1000-2W	94, 96	D3010	104, 108	MD003	11, 25, 126	MD258E	112
C1001-1H	98, 100, 101	D3011	103	MD004	19	MD308	27
C1001-1W	94, 96, 97	D3012	103, 107	MD005	22	MD314	26, 93, 134
C1001-2H	98, 100, 101	D3016	102, 107	MD006	22	MD317	26
C1001-2W	94, 96, 97	D3023	102, 107	MD007	27	MD318	25
C1002-1H	98, 101	D3024	103, 107	MD008	20	MD318-10	87
C1002-1W	94, 97	D3502	102	MD008E	112	MD325	4, 11, 24, 26, 89, 111, 126
C1002-2H	98, 101	D3503	103, 107, 108	MD009	21, 93, 134	MD346	4, 11, 27
C1002-2W	94, 97	D3505	103, 107	MD009E	113	MD354	22
C3000H	99, 100	D3509	103	MD010	25, 134	MD355	21
C3000W	95, 96	D3515	109, 110	MD011	19	MD356	11, 22, 111
C3001H	99, 100	D3517	109, 110	MD012	25	MD356E	113
C3001W	95, 96	D3519	107, 110	MD013	21	MD358	23, 126
C3002H	99, 101	D3533	102, 107	MD014	20, 89	MD359	20
C3002W	95, 97	D3542	102, 107, 110	MD016	22, 28, 38, 47	MD359B	50
C4000H	99, 100	D3543	102, 107, 110	MD017	19	MD359E	112
C4000W	95, 96	D3544	103, 107	MD018	20	MD360	4, 23, 24
C4001H	99, 101			MD020	23, 31	MD361	23
C4001W	95, 97			MD026	20, 27, 36, 46	MD362	47
						MD363	22

MD367	36, 46
MD368	34, 45
MD380	35, 46
MD413	24, 25
MD8300	21

MDA

—	
MDA002	41
MDA005	41
MDA007	41
MDA008	41
MDA040	42
MDA046	41
MDA067	42
MDA072	32, 42
MDA098	42
MDA106	41
MDA109	43
MDA113	43
MDA121	41
MDA138	42
MDA212	41
MDA401	42

MDB

—	
MDB063	34
MDB064	35
MDB100	38, 47
MDB101	39, 49
MDB102	36
MDB103	40
MDB104	40
MDB108	38
MDB112	34
MDB115	38, 48
MDB117	11, 37, 89
MDB118	37
MDB121	39
MDB123	29
MDB127	35
MDB128	40
MDB130	34

MDB131	37
MDB132	35
MDB134	36
MDB135	31, 33
MDB136	33
MDB140	39
MDB142	37, 134
MDB147	34
MDB150	40, 44, 49
MDB152	36
MDB154	39
MDB155	40
MDB158	38
MDB162	33
MDB163	33
MDB164	33
MDB165	33
MDB167	34
MDB169	39
MDB174	34
MDB180	33
MDB185	35
MDB214	39

MDC

—	
MDC217	30
MDC236	30
MDC239	30
MDC250	30
MDC250-11	88
MDC250-12	88
MDC252	30, 31
MDC252-11	31, 87
MDC255	30
MDC258	30
MDC258-12	88
MDC258-13	88

MDD

—	
MDD305	28
MDD308-11	88
MDD308-12	87

MDD311	28
MDD315	29
MDD316	25
MDD325-12	87
MDD332	26
MDD332-11	87
MDD332-12	87
MDD332-13	87
MDD334	28
MDD335	29
MDD338	28, 31
MDD339	28
MDD345	28, 93
MDD351	27
MDD410	29
MDD412	27, 97
MDD414	26

QL

—	
QL001	49
QL002	47
QL006	27, 45
QL007	21, 45
QL009	48
QL010	48
QL011	16, 48
QL017	28, 45
QL019	20, 23, 27, 36, 44, 45, 46
QL021	19, 23, 44, 45
QL022	25
QL023	26, 44
QL026	16
QL027	17, 39, 48
QL035	17
QL036	14, 17, 31
QL046	17
QL056	17
QR001	83
QR002	44, 83
QR005	83
QS003	23
QS004	22
QS009	21
QS011	23, 29, 39, 49

WP

—	
WP001	81, 82
WP001T	82
WP001L	82
WP001LT	82
WP001R	82
WP001RT	82
WP002	78, 84
WP002T	84
WP002L	84
WP002LT	84
WP002R	84
WP002RT	84



1. MDB142    2. MD314    3. MD010    4. MD009





MARDOM DECOR

Ratajska 11a

91-231 Łódź

Poland

tel +48 42 678 67 86

[www.mardomdecor.com](http://www.mardomdecor.com)

[www.mardom-sp.pl](http://www.mardom-sp.pl)

[mardomdecor@mardom-sp.pl](mailto:mardomdecor@mardom-sp.pl)



Mardom Decor

MARDOM  
DECOR